



中国认可  
国际互认  
检测  
TESTING  
CNAS L6666

**EMTEK**  
Access to the World

## EMC TEST REPORT

For

SOLAX POWER NETWORK TECHNOLOGY(ZHEJIANG) CO., LTD.

X1-AC

Model No.: X1-AC-3.0, X1-AC-3.6, X1-AC-4.6, X1-AC-5.0

Prepared for : SOLAX POWER NETWORK TECHNOLOGY(ZHEJIANG)  
CO., LTD.

Address : No. 288 Shizhu Road, Tonglu Economic Development  
Zone, Dongxing District, Tonglu City, Zhejiang Province,  
People's Republic of China

Prepared by : EMTEK (NINGBO) CO., LTD.

Address : 1/F ., Building 4, No. 1177, Lingyun Road, Ningbo National  
Hi-Tech Zone, Ningbo, Zhejiang, China

Tel: +86-574-27907998

Fax: +86-574-27721538

Report Number : EN180605013E

Date of Test : June 05, 2018 to October 09, 2018

Date of Report : October 16, 2018

## TABLE OF CONTENT

<b>TEST REPORT DESCRIPTION</b>	<b>PAGE</b>
<b>1. SUMMARY OF TEST RESULT .....</b>	<b>6</b>
<b>2. GENERAL INFORMATION.....</b>	<b>7</b>
2.1. Description of Device (EUT) .....	7
2.2. Description of Test Facility .....	8
2.3. Description of Support Device .....	8
2.4. Measurement Uncertainty .....	9
<b>3. MEASURING DEVICE AND TEST EQUIPMENT .....</b>	<b>10</b>
3.1. For Power Line Conducted Emission Measurement .....	10
3.2. For Radiated Emission Measurement .....	10
3.3. For Harmonic Current / Flicker Measurement .....	10
3.4. For Electrostatic Discharge Immunity Test .....	11
3.5. For RF Strength Susceptibility Test .....	11
3.6. For Electrical Fast Transient / Burst Immunity Test .....	11
3.7. For Surge Immunity Test .....	12
3.8. For Injected Current Susceptibility Test .....	12
3.9. For Magnetic Field Immunity Test .....	12
<b>4. POWER LINE CONDUCTED EMISSION MEASUREMENT .....</b>	<b>13</b>
4.1. Block Diagram of Test Setup .....	13
4.2. Measuring Standard .....	13
4.3. Power Line Conducted Emission Limits .....	13
4.4. EUT Configuration on Measurement .....	13
4.5. Operating Condition of EUT .....	14
4.6. Test Procedure.....	14
4.7. Measuring Results .....	14
<b>5. RADIATED EMISSION MEASUREMENT .....</b>	<b>19</b>
5.1. Block Diagram of Test Setup .....	19
5.2. Measuring Standard .....	19
5.3. Radiated Emission Limits .....	19
5.4. EUT Configuration on Test.....	20
5.5. Operating Condition of EUT .....	20
5.6. Test Procedure.....	20
5.7. Measuring Results .....	20
<b>6. HARMONIC CURRENT EMISSION MEASUREMENT.....</b>	<b>25</b>
6.1. Block Diagram of Test Setup .....	25
6.2. Measuring Standard .....	25
6.3. Operation Condition of EUT .....	25
6.4. Measuring Results .....	25
<b>7. VOLTAGE FLUCTUATION AND FLICKER MEASUREMENT .....</b>	<b>32</b>
7.1. Block Diagram of Test Setup .....	32
7.2. Measuring Standard .....	32
7.3. Operation Condition of EUT .....	32
7.4. Measuring Results .....	32
<b>8. IMMUNITY PERFORMANCE CRITERIA DESCRIPTION.....</b>	<b>36</b>
<b>9. ELECTROSTATIC DISCHARGE IMMUNITY TEST.....</b>	<b>37</b>
9.1. Block Diagram of Test Setup .....	37
9.2. Test Standard.....	37
9.3. Severity Levels and Performance Criterion .....	37
9.4. Operating Condition of EUT .....	38
9.5. Test Procedure.....	38
9.6. Test Results .....	38
<b>10. RF FIELD STRENGTH SUSCEPTIBILITY TEST .....</b>	<b>40</b>
10.1. Block Diagram of Test Setup .....	40

10.2.	Test Standard.....	40
10.3.	Severity Levels and Performance Criterion.....	41
10.4.	Operating Condition of EUT .....	41
10.5.	Test Procedure.....	41
10.6.	Test Results .....	41
<b>11.</b>	<b>ELECTRICAL FAST TRANSIENT/BURST IMMUNITY TEST .....</b>	<b>44</b>
11.1.	Block Diagram of Test Setup .....	44
11.2.	Test Standard.....	44
11.3.	Severity Levels and Performance Criterion.....	44
11.4.	Operating Condition of EUT .....	45
11.5.	Test Procedure.....	45
11.6.	Test Result.....	45
<b>12.</b>	<b>SURGE IMMUNITY TEST .....</b>	<b>47</b>
12.1.	Block Diagram of Test Setup .....	47
12.2.	Test Standard.....	47
12.3.	Severity Levels and Performance Criterion.....	47
12.4.	Operating Condition of EUT .....	48
12.5.	Test Procedure.....	48
12.6.	Test Result.....	48
<b>13.</b>	<b>INJECTED CURRENTS SUSCEPTIBILITY TEST.....</b>	<b>50</b>
13.1.	Block Diagram of Test Setup .....	50
13.2.	Test Standard.....	50
13.3.	Severity Levels and Performance Criterion.....	50
13.4.	Operating Condition of EUT .....	51
13.5.	Test Procedure.....	51
13.6.	Test Results .....	51
<b>14.</b>	<b>MAGNETIC FIELD SUSCEPTIBILITY TEST.....</b>	<b>53</b>
14.1.	Block Diagram of Test.....	53
14.2.	Test Standard.....	53
14.3.	Severity Levels and Performance Criterion.....	53
14.4.	Operating Condition of EUT .....	53
14.5.	Test Procedure.....	53
14.6.	Test Results .....	54
<b>15.</b>	<b>VOLTAGE DIPS AND INTERRUPTIONS TEST .....</b>	<b>56</b>
15.1.	Block Diagram of Test Setup .....	56
15.2.	Test Standard.....	56
15.3.	Severity Levels and Performance Criterion.....	56
15.4.	Operating Condition of EUT .....	57
15.5.	Test Procedure.....	57
15.6.	Test Result.....	57
<b>16.</b>	<b>PHOTOGRAPH.....</b>	<b>59</b>
16.1.	Photo of Conducted Emission Measurement.....	59
16.2.	Photo of Radiation Emission Measurement .....	59
16.3.	Photo of Harmonics and Flicker Test.....	60
16.4.	Photo of Electrostatic Discharge Test.....	60
16.5.	Photo of RF Field Strength Susceptibility Test .....	61
16.6.	Photo of Electrical Fast Transient / Burst Test.....	61
16.7.	Photo of Surge Test .....	62
16.8.	Photo of Injected Currents Susceptibility Test .....	62
16.9.	Photo of Magnetic Field Susceptibility Test .....	63
16.10.	Photo of Voltage Dips and Interruption Immunity Test .....	63

APPENDIX I (Photos of EUT) (6 Pages)

## TEST REPORT DESCRIPTION

Applicant : SOLAX POWER NETWORK TECHNOLOGY(ZHEJIANG) CO., LTD.

Manufacturer : SOLAX POWER NETWORK TECHNOLOGY(ZHEJIANG) CO., LTD.

Trade Mark : 

EUT : X1-AC

Model No. : X1-AC-3.0, X1-AC-3.6, X1-AC-4.6, X1-AC-5.0

Power Supply : AC Input: AC 220/230/240V, 50Hz  
AC Output: AC 220/230/240V, 50Hz, 4999W, 21.7A Max for 230VAC  
DC Input/Output: DC 70-400V, 35A Max

**Measurement Procedure Used:**

EN 61000-6-3:2007+A1:2011

EN 61000-3-12:2011(For Models X1-AC-4.6 and X1-AC-5.0)

EN 61000-3-11:2000(For Models X1-AC-4.6 and X1-AC-5.0)

EN 61000-3-2:2014(For Models X1-AC-3.0 and X1-AC-3.6)

EN 61000-3-3:2013(For Models X1-AC-3.0 and X1-AC-3.6)

EN 61000-6-1:2007, EN 61000-6-2:2005

(IEC 61000-4-2:2008, IEC 61000-4-3:2006+A1:2007+A2:2010, IEC 61000-4-4:2012, IEC 61000-4-5:2014, IEC 61000-4-6:2013, IEC 61000-4-8:2009, IEC 61000-4-11:2004)

The device described above is tested by EMTEK (NINGBO) CO., LTD. to determine the maximum emission levels emanating from the device and the severe levels of the device can endure and its performance criterion. The measurement results are contained in this test report and EMTEK (NINGBO) CO., LTD. is assumed full of responsibility for the accuracy and completeness of these measurements. Also, this report shows that the EUT (Equipment under Test) is technically compliant with the EN 61000-6-3, EN 61000-6-1, EN 61000-6-2, EN 61000-3-11, EN 61000-3-12, EN 61000-3-2 and EN 61000-3-3 requirements.

This report applies to above tested sample only and shall not be reproduced in part without written approval of EMTEK (NINGBO) CO., LTD.

Date of Test : June 05, 2018 to October 09, 2018

Prepared by : Sophia  
Sophia/Engineer

Reviewer : Kuki  
Kuki/Supervisor

Approved & Authorized Signer : Tony Wei  
Tony wei/Manager

### Modified History

Version	Report No.	Revision date	Summary
Ver.1.0	EN180605013E	\	Original Report

## 1. SUMMARY OF TEST RESULT

<b>EMISSION</b>			
Description of Test Item	Standard	Limits	Results
Conducted Disturbance at Mains Terminals*	EN 61000-6-3:2007+A1:2011	Table 2	Pass
Radiated Disturbance	EN 61000-6-3:2007+A1:2011	Table 1	Pass
Harmonics*	EN 61000-3-12:2011	Table 3	Pass
Voltage fluctuation and flicker*	EN 61000-3-11:2000	Section 5	Pass
Harmonics	EN 61000-3-2:2014	Class A	Pass
Voltage fluctuation and flicker	EN 61000-3-3:2013	Section 5	Pass
<b>IMMUNITY ( EN 61000-6-1:2007, EN 61000-6-2:2005)</b>			
Description of Test Item	Basic Standard	Performance Criteria	Results
Electrostatic Discharge (ESD)	IEC 61000-4-2:2008	B	Pass
Radio-Frequency, Continuous Radiated Disturbance*	IEC 61000-4-3:2006+ A1:2007+A2:2010	A	Pass
EFT/B Immunity*	IEC 61000-4-4:2012	B	Pass
Surge Immunity*	IEC 61000-4-5:2014	B	Pass
Conducted RF Immunity*	IEC 61000-4-6:2013	A	Pass
Power Frequency Magnetic Field*	IEC 61000-4-8:2009	A	Pass
Voltage dips*	IEC 61000-4-11:2004	B&C	Pass
Voltage interruptions*		C	Pass
<p>Note: 1. N/A is an abbreviation for Not Applicable.            2. "*" represent the tests were carried out at: EMTEK (SHENZHEN) CO., LTD            The Certificate Registration Number is L2291, Accredited by CNAS, 2016.10.24            The certificate is valid until 2022.10.28</p>			

## 2. GENERAL INFORMATION

### 2.1. Description of Device (EUT)

EUT	: X1-AC
Model Number	: X1-AC-3.0, X1-AC-3.6, X1-AC-4.6, X1-AC-5.0 (Note: All models are identical except power. We prepared X1-AC-5.0 for EMC tests, Model X1-AC-3.6 For Harmonics and Voltage fluctuation and flicker test.)
Test Voltage	: AC 230V/50Hz
Highest frequency	: 50MHz
Applicant	: SOLAX POWER NETWORK TECHNOLOGY(ZHEJIANG) CO., LTD.
Address	: No. 288 Shizhu Road, Tonglu Economic Development Zone, Dongxing District, Tonglu City, Zhejiang Province, People's Republic of China
Manufacturer	: SOLAX POWER NETWORK TECHNOLOGY(ZHEJIANG) CO., LTD.
Address	: No. 288 Shizhu Road, Tonglu Economic Development Zone, Dongxing District, Tonglu City, Zhejiang Province, People's Republic of China
Date of Received	: June 05, 2018
Date of Test	: June 05, 2018 to October 09, 2018

## 2.2. Description of Test Facility

### Site Description

EMC Lab. A : Accredited by CNAS, 2016.12.20  
The certificate is valid until 2023.1.20  
The Laboratory has been assessed and proved to be in compliance with  
CNAS-CL01:2006 (identical to ISO/IEC 17025:2005)  
The Certificate Registration Number is L6666.

Accredited by Industry Canada, November 14, 2016  
The Certificate Registration Number is 46405-9469.

Name of Firm : EMTEK (NINGBO) CO., LTD.  
Site Location : 1F Building 4, 1177#, Lingyun Road, National Hi-Tech Zone, Ningbo,  
Zhejiang, China

EMC Lab. B : Accredited by CNAS, 2016.10.24  
The certificate is valid until 2022.10.28  
The Laboratory has been assessed and proved to be in compliance with  
CNAS-CL01:2006 (identical to ISO/IEC 17025:2005)  
The Certificate Registration Number is L2291.

Accredited by TUV Rheinland Shenzhen 2016.5.19  
The Laboratory has been assessed according to the requirements ISO/IEC  
17025.

Accredited by FCC, August 06, 2018  
The certificate is valid until August 07, 2020  
Designation Number: CN1204  
Test Firm Registration Number: 882943

Accredited by Industry Canada, November 24, 2015  
The Certificate Registration Number is 4480A.

Accredited by A2LA, August 08, 2018  
The certificate is valid until August 31, 2020  
The Certificate Number is 4321.01.

Name of Firm : EMTEK (SHENZHEN) CO., LTD.

Site Location : Bldg 69, Majialong Industry Zone, Nanshan District, Shenzhen, Guangdong,  
China

## 2.3. Description of Support Device

Battery : M/N: T-BAT H 4.0  
Manufacturer: SOLAX



## 2.4. Measurement Uncertainty

Conducted Emission Uncertainty	: 3.06dB (9K-150KHz) 2.44dB (150K-30MHz)
Radiated Emission Uncertainty (3m Chamber)	: 3.44dB (Polarize: H) (30MHz-1000MHz) 3.78dB (Polarize: V) (30MHz-1000MHz)
Uncertainty for Flicker test	: 0.07%
Uncertainty for Harmonic test	: 1.8%
Uncertainty for C/S Test	: 1.45dB (Using CDN Test) 2.37dB (Using EM Clamp Test)
Uncertainty for R/S Test	: 2.10dB(80MHz-200MHz) 1.76dB(200MHz-1000MHz)

### 3. MEASURING DEVICE AND TEST EQUIPMENT

#### 3.1. For Power Line Conducted Emission Measurement

Item	Equipment	Manufacturer	Model No.	Serial No.	Last Cal.	Cal. Interval
1.	Test Receiver	Rohde & Schwarz	ESCS30	828985/018	May 20, 2018	1 Year
2.	L.I.S.N.	Schwarzbeck	NNLK8129	8129-203	May 19, 2018	1 Year
3.	50Ω Coaxial Switch	Anritsu	MP59B	M20531	May 20, 2018	1 Year
4.	Pulse Limiter	Rohde & Schwarz	ESH3-Z2	100006	May 19, 2018	1 Year

#### 3.2. For Radiated Emission Measurement

Item	Equipment	Manufacturer	Model No.	Serial No.	Last Cal.	Cal. Interval
1.	Spectrum Analyzer	Rohde & Schwarz	ESCI	101107	July 14, 2018	1 Year
2.	EMI Test Receiver	Rohde & Schwarz	ESCI	101107	July 14, 2018	1 Year
3.	Pre-Amplifier	CD	PAP-0203	22015	July 14, 2018	1 Year
4.	Bilog Antenna	Schwarzbeck	VULB9163	9163-467	July 14, 2018	1 Year
5.	Cable	Huber + Suhner	CBL3-NN-0.5M	101216-21405 00-2	July 14, 2018	1 Year
6.	Cable	Huber + Suhner	CBL3-NN-3.0M	101216-21430 00-2	July 14, 2018	1 Year
7.	Cable	Huber + Suhner	CBL3-NN-9.0M	101216-21490 00	July 14, 2018	1 Year

#### 3.3. For Harmonic Current / Flicker Measurement

Item	Equipment	Manufacturer	Model No.	Serial No.	Last Cal.	Cal. Interval
1.	45KVA AC Power source	Teseq	NSG 1007-45/45KVA	1305A02873	May 19, 2018	1 Year
2.	Signal conditioning Unit	Teseq	CCN 1000-3	1305A02873	May 19, 2018	1 Year
3.	Three phase impedance network	Teseq/Germany	INA2197/37A	1305A02873	May 19, 2018	1 Year
4.	Three phase impedance network	Teseq/Germany	INA 2196/75A	1305A02874	May 19, 2018	1 Year
5.	Proflin 2100 AC Switching Unit	Teseq/Germany	NSG2200-3	A22714	May 19, 2018	1 Year
6.	AC Power source	California Instruments	5001iX-CTS-400 -413	59739	July 14, 2018	1 Year
7.	Harmonic/ flicker analyzer	California Instruments	PACS-1	72795	July 14, 2018	1 Year

### 3.4. For Electrostatic Discharge Immunity Test

Item	Equipment	Manufacturer	Model No.	Serial No.	Last Cal.	Cal. Interval
1.	ESD Tester	EM TEST	ESD 30C	V0526100500	July 16, 2018	1 Year

### 3.5. For RF Strength Susceptibility Test

Item	Equipment	Manufacturer	Model No.	Serial No.	Last Cal.	Cal. Interval
1	Signal Generator	Agilent	N5181A	MY50145187	May 19, 2018	1 Year
2	RF Power Meter. Dual Channel	BOONTON	4232A	10539	May 20, 2018	1 Year
3	50ohm Diode Power Sensor	BOONTON	51011EMC	34236/34238	May 20, 2018	1 Year
4	Field Strength Meter	DARE	RSS1006A	10I00037SO22	May 20, 2018	1 Year
5	50ohm Diode Power Sensor	BOONTON	51011EMC	36164	May 20, 2018	1 Year
6	Power Amplifier	MILMEGA	80RF1000-175	1059345	May 19, 2018	1 Year
7	Power Amplifier	MILMEGA	AS0102-55	1018770	May 19, 2018	1 Year
8	Power Amplifier	MILMEGA	AS1860-50	1059346	May 19, 2018	1 Year
9	Log.-Per. Antenna	SCHWARZBECK	VULP 9118E	811	May 20, 2018	1 Year
10	Broad-Band Horn Antenna	SCHWARZBECK	STLP 9149	9149-227	May 20, 2018	1 Year
11	Multi-function interface system	DARE	CTR1009B	12I00250SNO 72	N/A	N/A
12	Automatic switch group	DARE	RSW1004A	N/A	N/A	N/A

### 3.6. For Electrical Fast Transient / Burst Immunity Test

Item	Equipment	Manufacturer	Model No.	Serial No.	Last Cal.	Cal. Interval
1.	Burst Tester	HAEFELY	PEFT4010	080981-16	May 20, 2018	1Year
2.	Coupling Clamp	HAEFELY	IP-4A	147147	May 20, 2018	1Year
3.	Three phase CDN	Teseq	CDN 163	202	May 20, 2018	1 Year

### 3.7. For Surge Immunity Test

Item	Equipment	Manufacturer	Model No.	Serial No.	Last Cal.	Cal. Interval
1.	Surge Controller	HAEFELY	Psurge 8000	174031	May 20, 2018	1Year
2.	Impulse Module	HAEFELY	PIM 100	174124	May 20, 2018	1Year
3.	Coupling Decoupling Filter	HAEFELY	PCD 130	172181	May 20, 2018	1Year
4.	Coupling Module	HAEFELY	PCD122	174354	May 20, 2018	1Year
5.	Surge Impulse Module	HAEFELY	PIM 120	174435	May 20, 2018	1Year
6.	Coupling Module	HAEFELY	PCD 126A	174387	May 20, 2018	1Year
7.	Impulse Module	HAEFELY	PIM 110	174391	May 20, 2018	1Year
8.	Impulse Module	HAEFELY	PIM 150	178707	May 20, 2018	1Year

### 3.8. For Injected Current Susceptibility Test

Item	Equipment	Manufacturer	Model No.	Serial No.	Last Cal.	Cal. Interval
1.	Simulator	EMTEST	CWS500C	0900-12	May 20, 2018	1Year
2.	CDN	EMTEST	CDN-M2	5100100100	May 20, 2018	1Year
3.	CDN	EMTEST	CDN-M3	0900-11	May 20, 2018	1Year
4.	Injection Clamp	EMTEST	F-2031-23MM	368	May 20, 2018	1Year
5.	Attenuator	EMTEST	ATT6	0010222A	May 20, 2018	1Year
6.	Three phase CDN	Teseq	CDN M332S	32655	May 20, 2018	1 Year
7.	Three phase CDN	Teseq	CDN M432S	33670	May 20, 2018	1 Year
8.	Three phase CDN	Teseq	CDN M432-3LNS	34048	May 20, 2018	1 Year
9.	Three phase CDN	Teseq	CDN M532S	33799	May 20, 2018	1 Year

### 3.9. For Magnetic Field Immunity Test

Item	Equipment	Manufacturer	Model No.	Serial No.	Last Cal.	Cal. Interval
1.	Magnetic Field Tester	HAEFELY	MAG100	250040.1	May 19, 2018	1Year

## 4. POWER LINE CONDUCTED EMISSION MEASUREMENT

### 4.1. Block Diagram of Test Setup

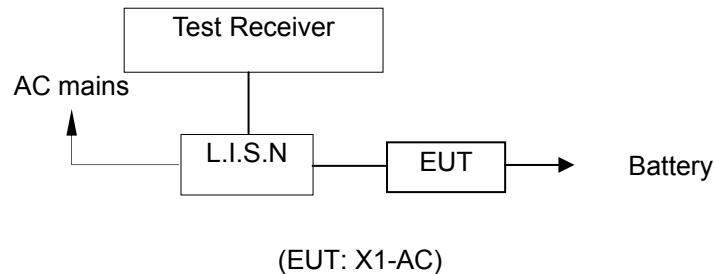

### 4.2. Measuring Standard

EN 61000-6-3:2007+A1:2011

### 4.3. Power Line Conducted Emission Limits

For AC mains port:

Frequency (MHz)	Limit (dB $\mu$ V)	
	Quasi-peak Level	Average Level
0.15 ~ 0.50	66.0 ~ 56.0 *	56.0 ~ 46.0 *
0.50 ~ 5.00	56.0	46.0
5.00 ~ 30.00	60.0	50.0

NOTE1-The lower limit shall apply at the transition frequencies.  
NOTE2-The limit decreases linearly with the logarithm of the frequency in the range 0.15MHz to 0.50MHz.

For DC power port:

Frequency (MHz)	Limit (dB $\mu$ V)	
	Quasi-peak Level	Average Level
0.15 ~ 0.50	79	66
0.50 ~ 30.00	73	60

NOTE-The lower limit shall apply at the transition frequencies.

### 4.4. EUT Configuration on Measurement

The following equipments are installed on Conducted Emission Measurement to meet EN 61000-6-3 requirements and operating in a manner which tends to maximize its emission characteristics in a normal application.

EUT : X1-AC  
Model Number : X1-AC-5.0

#### 4.5. Operating Condition of EUT

4.5.1. Turn on the power.

4.5.2. After that, let the EUT work in test mode (Charging, Discharging) and measure it.

#### 4.6. Test Procedure

The EUT is put on the plane 0.8m high above the ground by insulating support and the AC output power ports connected to the AC mains through Line Impedance Stability Network (L.I.S.N). This provided a 50ohm coupling impedance for the tested equipments. All of the output lines are investigated to find out the maximum conducted emission according to the EN 61000-6-3 regulations during conducted emission measurement.

The bandwidth of the field strength meter (R&S Test Receiver ESCI) is set at 9kHz in 150kHz~30MHz and 200Hz in 9kHz~150kHz.

The frequency range from 150kHz to 30MHz is investigated

#### 4.7. Measuring Results

**PASS.**

Please refer to the following pages.

(The tests were carried out at: EMTEK (SHENZHEN) CO., LTD. The Certificate Registration Number is L2291, Accredited by CNAS, 2016.10.24, The certificate is valid until 2022.10.28)

**Test data:**

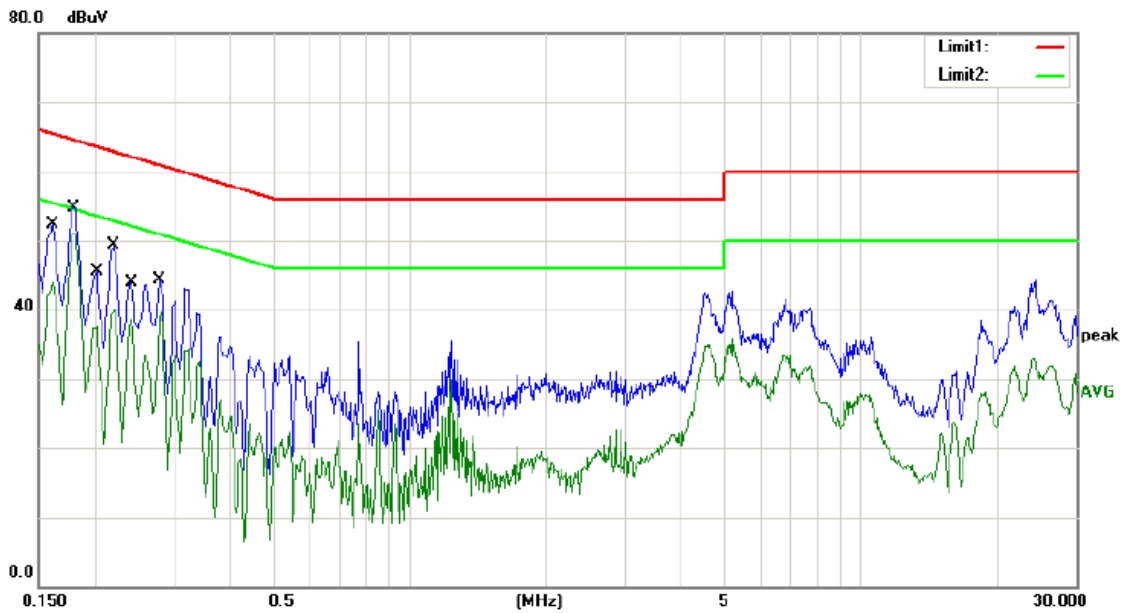

Site site #1 Phase: **L1** Temperature: 24  
 Limit: (CE)EN61000-6-3\_QP Power: AC 230V/50Hz Humidity: 59 %  
 Mode: DISCHARGING  
 Note:

No.	Mk.	Freq. MHz	Reading Level dBuV	Correct Factor dB	Measure- ment dBuV	Limit dBuV	Over dB	Detector	Comment
1		0.1620	42.10	10.10	52.20	65.36	-13.16	QP	
2		0.1620	33.00	10.10	43.10	55.36	-12.26	AVG	
3		0.1820	42.40	10.09	52.49	64.39	-11.90	QP	
4	*	0.1820	40.80	10.09	50.89	54.39	-3.50	AVG	
5		0.2020	35.40	10.09	45.49	63.53	-18.04	QP	
6		0.2020	25.70	10.09	35.79	53.53	-17.74	AVG	
7		0.2220	39.20	10.09	49.29	62.74	-13.45	QP	
8		0.2220	30.00	10.09	40.09	52.74	-12.65	AVG	
9		0.2420	33.70	10.09	43.79	62.03	-18.24	QP	
10		0.2420	28.50	10.09	38.59	52.03	-13.44	AVG	
11		0.2780	34.20	10.09	44.29	60.88	-16.59	QP	
12		0.2780	28.80	10.09	38.89	50.88	-11.99	AVG	

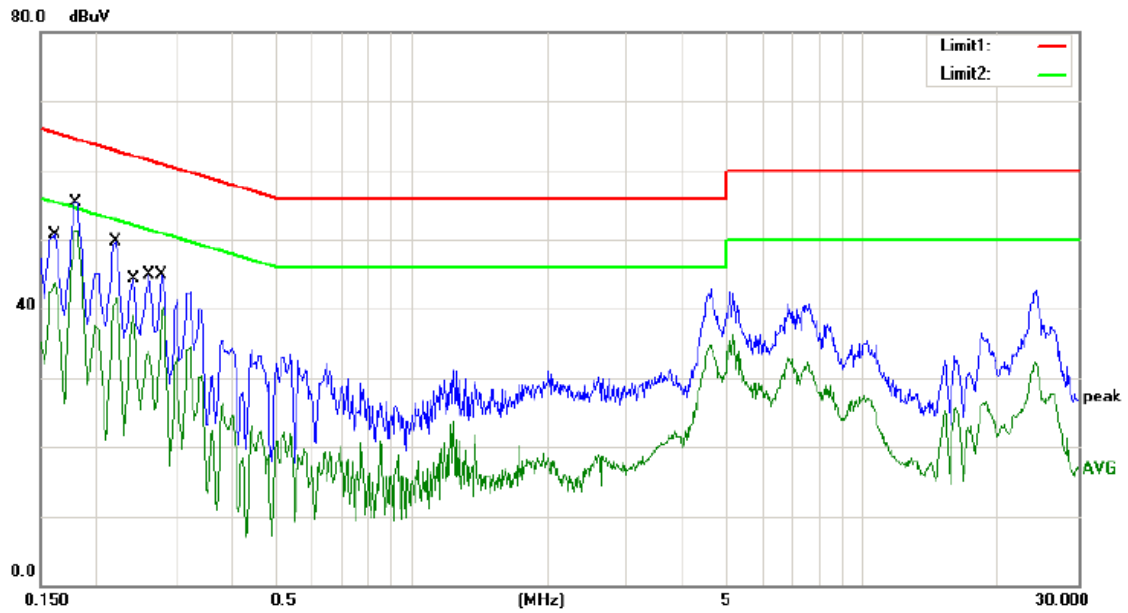

Site site #1  
 Limit: (CE)EN61000-6-3\_QP  
 Mode: DISCHARGING  
 Note:

Phase: **N**  
 Power: AC 230V/50Hz

Temperature: 24  
 Humidity: 59 %

No.	Mk.	Freq. MHz	Reading Level dBuV	Correct Factor dB	Measure- ment dBuV	Limit dBuV	Over dB	Detector	Comment
1		0.1620	40.50	10.10	50.60	65.36	-14.76	QP	
2		0.1620	33.50	10.10	43.60	55.36	-11.76	AVG	
3		0.1820	43.20	10.09	53.29	64.39	-11.10	QP	
4	*	0.1820	41.10	10.09	51.19	54.39	-3.20	AVG	
5		0.2220	39.50	10.09	49.59	62.74	-13.15	QP	
6		0.2220	31.40	10.09	41.49	52.74	-11.25	AVG	
7		0.2420	34.10	10.09	44.19	62.03	-17.84	QP	
8		0.2420	29.00	10.09	39.09	52.03	-12.94	AVG	
9		0.2620	34.80	10.09	44.89	61.37	-16.48	QP	
10		0.2620	23.70	10.09	33.79	51.37	-17.58	AVG	
11		0.2780	34.80	10.09	44.89	60.88	-15.99	QP	
12		0.2780	29.50	10.09	39.59	50.88	-11.29	AVG	



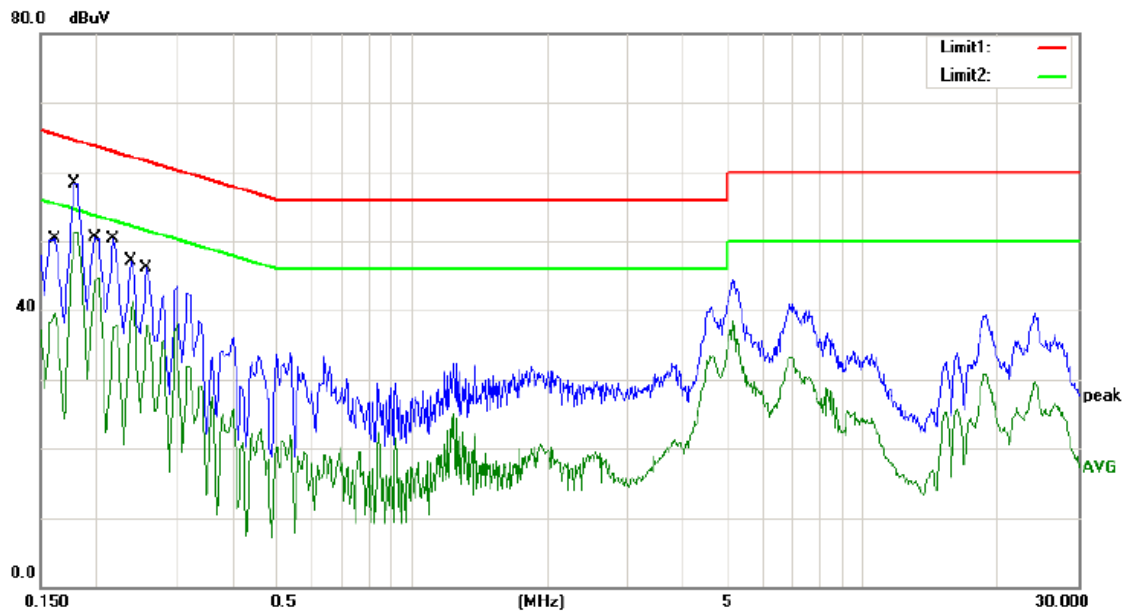

Site site #1 Phase: **N** Temperature: 24  
 Limit: (CE)EN61000-6-3\_QP Power: AC 230V/50Hz Humidity: 59 %  
 Mode: CHARGING  
 Note:

No.	Mk.	Freq. MHz	Reading Level dBuV	Correct Factor dB	Measure- ment dBuV	Limit dBuV	Over dB	Detector	Comment
1		0.1620	40.10	10.10	50.20	65.36	-15.16	QP	
2		0.1620	29.30	10.10	39.40	55.36	-15.96	AVG	
3		0.1780	48.10	10.09	58.19	64.58	-6.39	QP	
4	*	0.1780	41.20	10.09	51.29	54.58	-3.29	AVG	
5		0.1980	40.30	10.09	50.39	63.69	-13.30	QP	
6		0.1980	34.20	10.09	44.29	53.69	-9.40	AVG	
7		0.2180	40.20	10.09	50.29	62.89	-12.60	QP	
8		0.2180	27.40	10.09	37.49	52.89	-15.40	AVG	
9		0.2380	37.00	10.09	47.09	62.17	-15.08	QP	
10		0.2380	30.30	10.09	40.39	52.17	-11.78	AVG	
11		0.2580	35.90	10.09	45.99	61.50	-15.51	QP	
12		0.2580	27.70	10.09	37.79	51.50	-13.71	AVG	

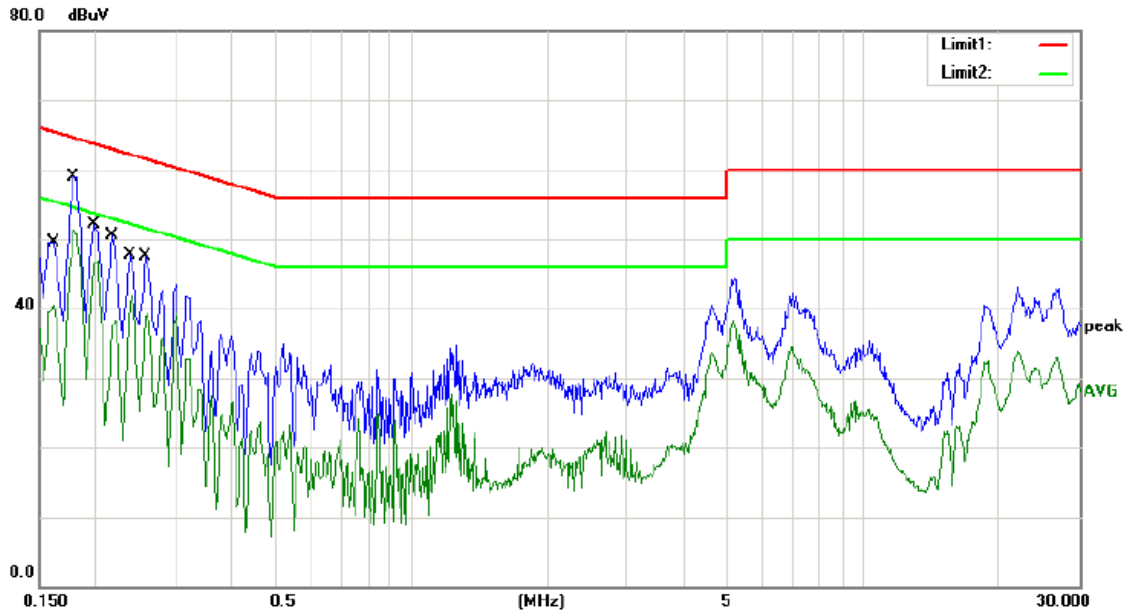

Site site #1  
 Limit: (CE)EN61000-6-3\_QP  
 Mode: CHARGING  
 Note:

Phase: **L1**  
 Power: AC 230V/50Hz

Temperature: 24  
 Humidity: 59 %

No.	Mk.	Freq. MHz	Reading Level dBuV	Correct Factor dB	Measure- ment dBuV	Limit dBuV	Over dB	Detector	Comment
1		0.1620	39.40	10.10	49.50	65.36	-15.86	QP	
2		0.1620	30.30	10.10	40.40	55.36	-14.96	AVG	
3		0.1780	48.80	10.09	58.89	64.58	-5.69	QP	
4	*	0.1780	41.20	10.09	51.29	54.58	-3.29	AVG	
5		0.1980	41.90	10.09	51.99	63.69	-11.70	QP	
6		0.1980	36.30	10.09	46.39	53.69	-7.30	AVG	
7		0.2180	40.30	10.09	50.39	62.89	-12.50	QP	
8		0.2180	27.40	10.09	37.49	52.89	-15.40	AVG	
9		0.2380	37.50	10.09	47.59	62.17	-14.58	QP	
10		0.2380	31.00	10.09	41.09	52.17	-11.08	AVG	
11		0.2580	37.30	10.09	47.39	61.50	-14.11	QP	
12		0.2580	28.80	10.09	38.89	51.50	-12.61	AVG	

## 5. RADIATED EMISSION MEASUREMENT

### 5.1. Block Diagram of Test Setup

#### 5.1.1. Block diagram of connection between the EUT and simulators

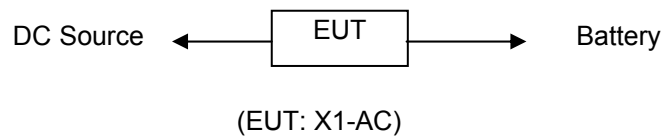

#### 5.1.2. Block diagram of test setup (In chamber)

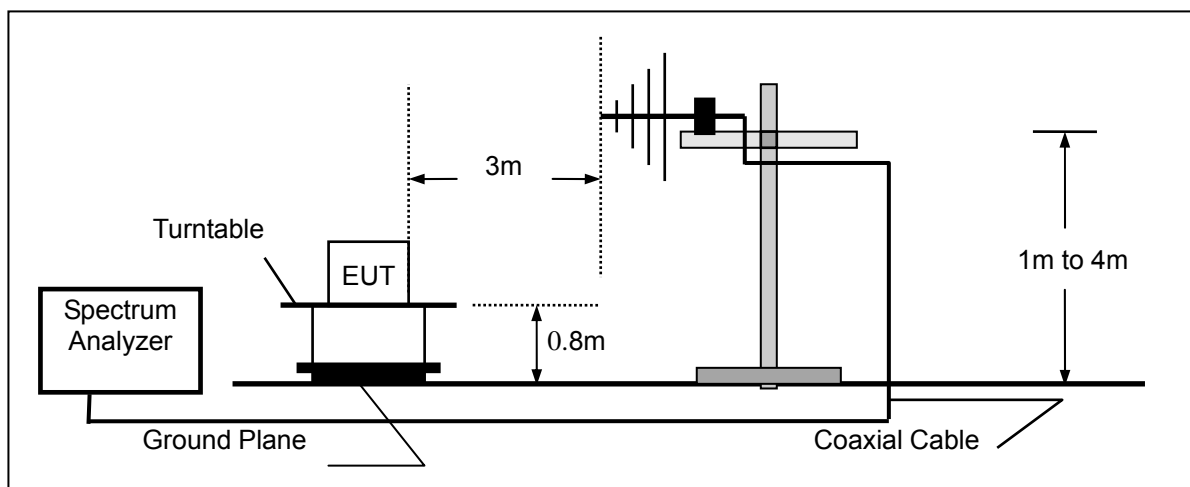

(EUT: X1-AC)

### 5.2. Measuring Standard

EN 61000-6-3:2007+A1:2011

### 5.3. Radiated Emission Limits

All emanations from devices or system shall not exceed the level of field strengths specified below:

FREQUENCY (MHz)	DISTANCE (Meters)	FIELD STRENGTHS LIMIT (dB $\mu$ V/m)
30 ~ 230	3	40
230 ~ 1000	3	47

FREQUENCY (GHz)	DISTANCE (Meters)	FIELD STRENGTHS LIMIT	
		Average (dB $\mu$ V/m)	Peak (dB $\mu$ V/m)
1~3	3	50	70
3~6	3	54	74

Note: (1) The smaller limit shall apply at the combination point between two frequency bands.

(2) Distance refers to the distance in meters between the measuring instrument antenna and the closed point of any part of the EUT.

#### 5.4. EUT Configuration on Test

The EN 61000-6-3 regulations test method must be used to find the maximum emission during radiated emission measurement.

#### 5.5. Operating Condition of EUT

5.5.1. Turn on the power.

5.5.2. After that, let the EUT work in test mode (Charging, Discharging) and measure it.

#### 5.6. Test Procedure

The EUT is placed on a turntable which is 0.8 meter high above the ground. The turntable can rotate 360 degrees to determine the position of the maximum emission level. The EUT is set 3 meters away from the receiving antenna that is mounted on an antenna tower. The antenna can be moved up and down from 1 to 4 meters to find out the maximum emission level. Bilog antenna (calibrated by Dipole Antenna) is used as a receiving antenna. Both horizontal and vertical polarization of the antenna is set on test.

The bandwidth of the Receiver (ESCI) is set at 120kHz.

#### 5.7. Measuring Results

**PASS.**

The frequency range from 30MHz to 1000MHz is investigated.

Please refer to the following pages.

**Test data:**

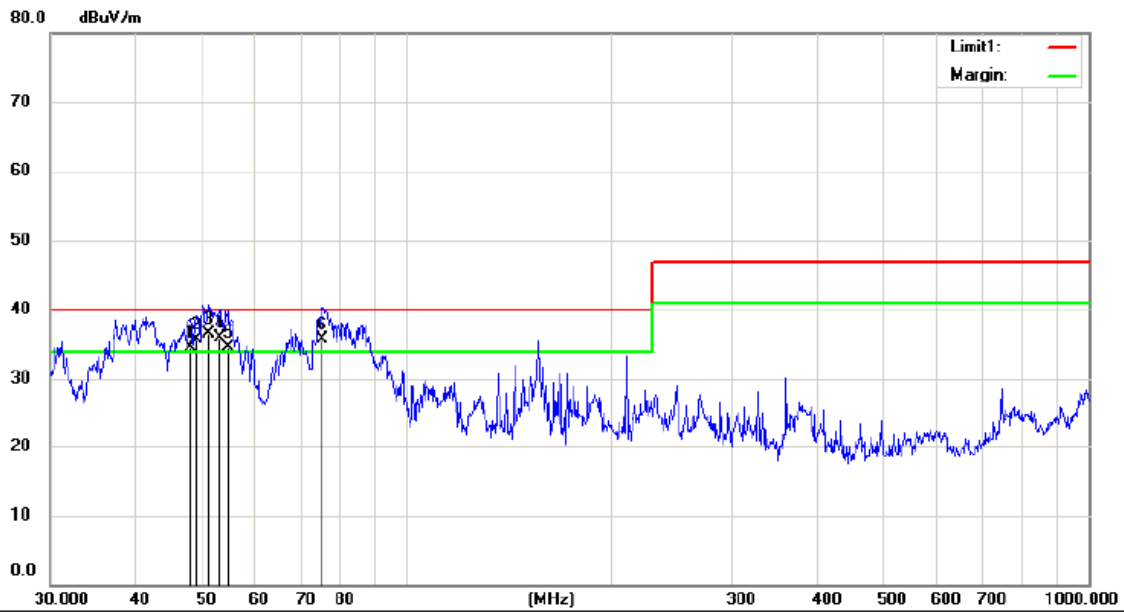

Site site #1 Polarization: *Vertical* Temperature: 22 C  
 Limit: (RE) EN 61000-6-3 Power: AC 230V/50Hz Humidity: 51 %  
 Mode: DISCHARGING  
 Note:

No.	Mk.	Freq. MHz	Reading Level dBuV	Correct Factor dB	Measure- ment dBuV/m	Limit dBuV/m	Over dB	Detector	Antenna Height cm	Table Degree	Comment
1	!	48.1625	54.45	-19.85	34.60	40.00	-5.40	QP			
2	!	49.1865	55.23	-19.53	35.70	40.00	-4.30	QP			
3	*	51.3005	55.97	-19.47	36.50	40.00	-3.50	QP			
4	!	53.1313	55.46	-19.56	35.90	40.00	-4.10	QP			
5	!	54.6428	54.31	-19.71	34.60	40.00	-5.40	QP			
6	!	75.1822	61.55	-25.75	35.80	40.00	-4.20	QP			

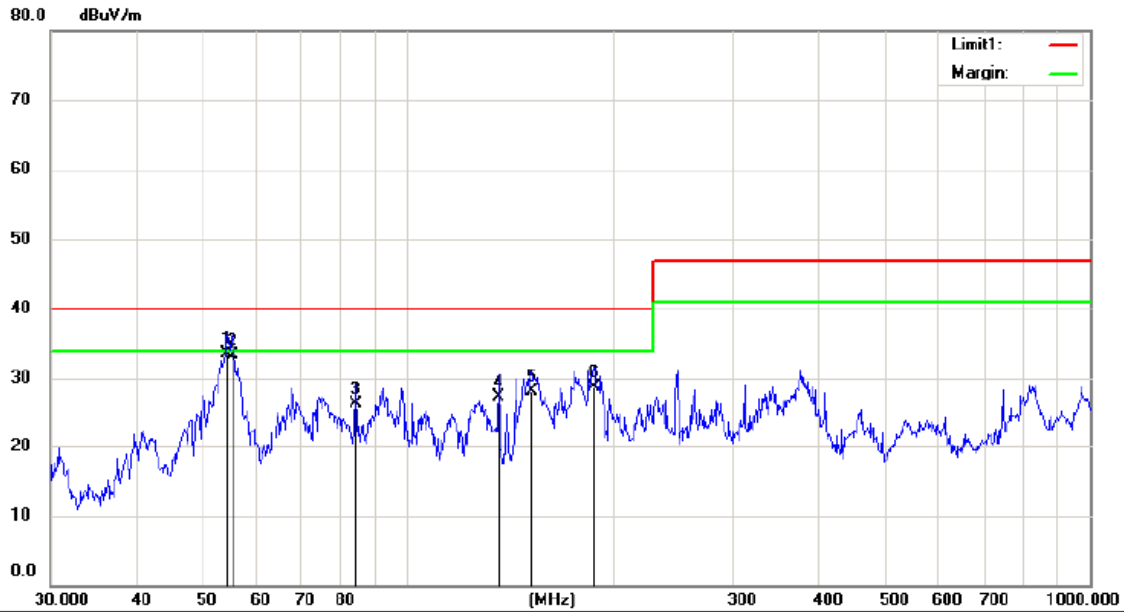

Site site #1 Polarization: *Horizontal* Temperature: 22 C  
 Limit: (RE) EN 61000-6-3 Power: AC 230V/50Hz Humidity: 51 %  
 Mode:DISCHARGING

Note:

No.	Mk.	Freq. MHz	Reading Level dBuV	Correct Factor dB	Measure- ment dBuV/m	Limit dBuV/m	Over dB	Detector	Antenna Height cm	Table Degree	Comment
1	*	54.4515	53.16	-19.66	33.50	40.00	-6.50	QP			
2		55.4147	53.29	-19.89	33.40	40.00	-6.60	QP			
3		84.1100	51.82	-25.52	26.30	40.00	-13.70	QP			
4		135.9821	53.23	-25.83	27.40	40.00	-12.60	QP			
5		152.1297	53.20	-25.10	28.10	40.00	-11.90	QP			
6		187.7530	51.62	-22.92	28.70	40.00	-11.30	QP			

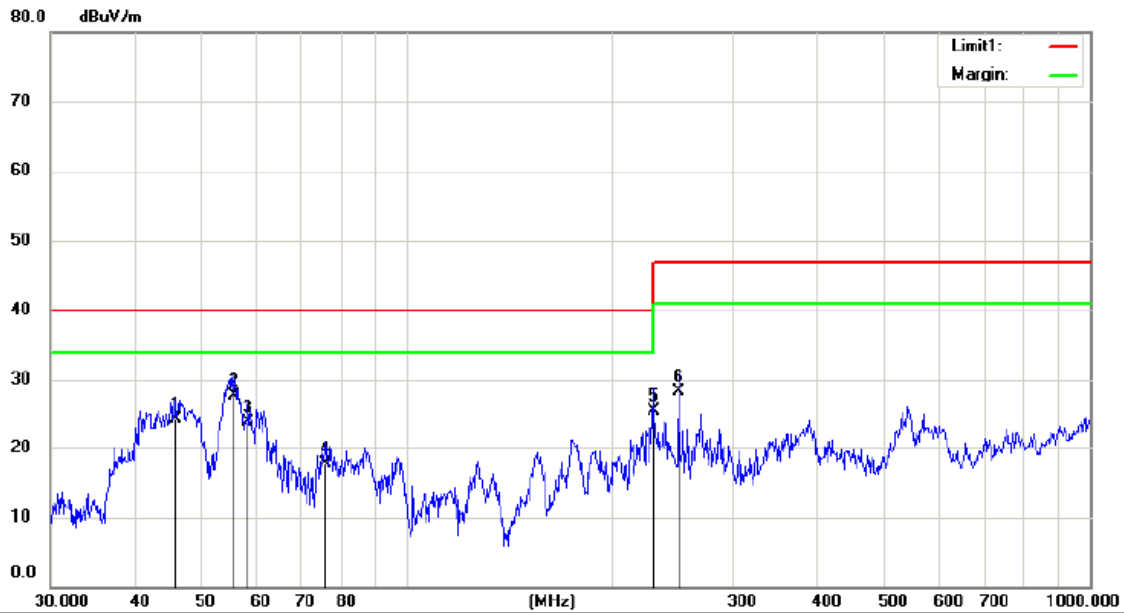

Site site #1 Polarization: *Horizontal* Temperature: 22 C  
 Limit: (RE) EN 61000-6-3 Power: AC 230V/50Hz Humidity: 51 %  
 Mode: CHARGING  
 Note:

No.	Mk.	Freq. MHz	Reading Level dBuV	Correct Factor dB	Measure- ment dBuV/m	Limit dBuV/m	Over dB	Detector	Antenna Height cm	Table Degree	Comment
1		45.6946	43.81	-19.51	24.30	40.00	-15.70	QP			
2	*	55.8046	47.69	-19.99	27.70	40.00	-12.30	QP			
3		58.4074	45.51	-21.51	24.00	40.00	-16.00	QP			
4		75.9772	43.63	-25.83	17.80	40.00	-22.20	QP			
5		229.2930	46.98	-21.38	25.60	40.00	-14.40	QP			
6		249.4250	49.76	-21.46	28.30	47.00	-18.70	QP			

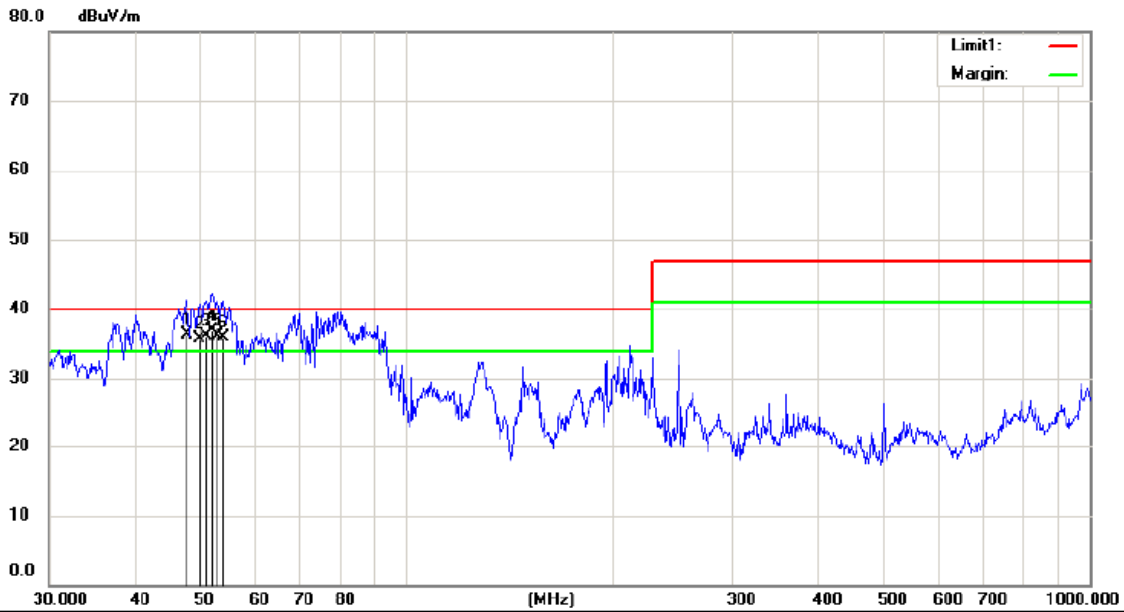

Site site #1 Polarization: *Vertical* Temperature: 22 C  
 Limit: (RE) EN 61000-6-3 Power: AC 230V/50Hz Humidity: 51 %  
 Mode: CHARGING  
 Note:

No.	Mk.	Freq. MHz	Reading Level dBuV	Correct Factor dB	Measure- ment dBuV/m	Limit dBuV/m	Over dB	Detector	Antenna Height cm	Table Degree	Comment
1	!	47.6584	56.11	-19.81	36.30	40.00	-3.70	QP			
2	!	49.8814	55.02	-19.32	35.70	40.00	-4.30	QP			
3	!	50.9420	55.62	-19.42	36.20	40.00	-3.80	QP			
4	*	51.8430	56.55	-19.55	37.00	40.00	-3.00	QP			
5	!	52.9453	55.77	-19.57	36.20	40.00	-3.80	QP			
6	!	53.8817	55.55	-19.55	36.00	40.00	-4.00	QP			



## 6. HARMONIC CURRENT EMISSION MEASUREMENT

### 6.1. Block Diagram of Test Setup

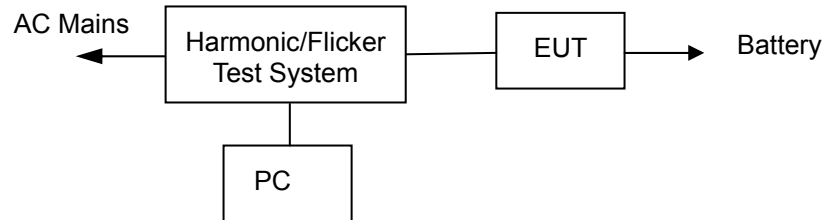

(EUT: X1-AC)

### 6.2. Measuring Standard

EN 61000-3-12:2011  
EN 61000-3-2:2014

### 6.3. Operation Condition of EUT

6.3.1. Turn on the power.

6.3.2. After that, let the EUT work in test mode (ON) and measure it.

### 6.4. Measuring Results

**PASS.**

Please refer to the following pages.

(Model X1-AC-5.0 tests were carried out at: EMTEK (SHENZHEN) CO., LTD. The Certificate Registration Number is L2291, Accredited by CNAS, 2016.10.24, The certificate is valid until 2022.10.28)

**Harmonics – Class-A per Ed. 4.0 (2014)(Run time)**

EUT: X1-AC(X1-AC-3.6) Tested by: J  
 Test category: Class-A per Ed. 4.0 (2014) (European limits) Test Margin: 100  
 Test date: 2018/8/30 Start time: 15:07:07 End time: 15:09:58  
 Test duration (min): 2.5 Data file name: H-000460.cts\_data  
 Comment: ON  
 Customer: SOLAX

**Test Result: Pass** **Source qualification: Normal**

Current & voltage waveforms

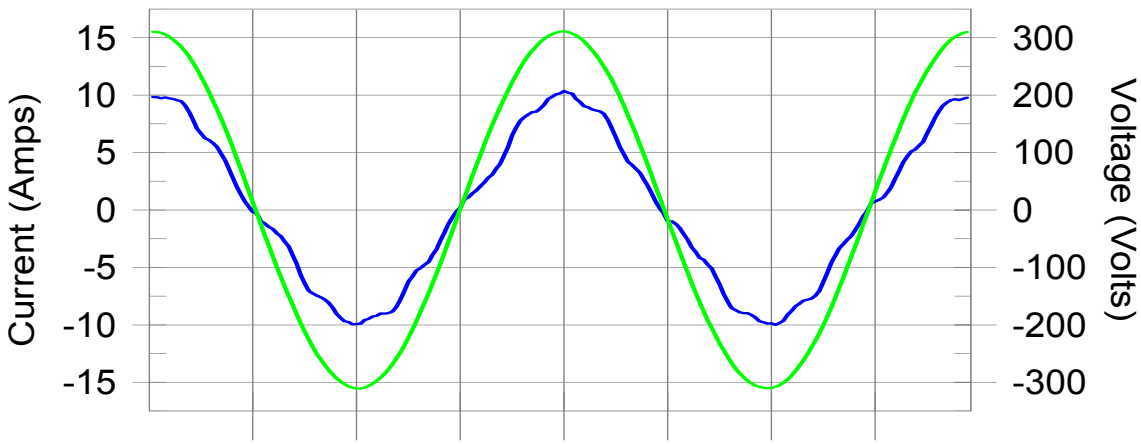

Harmonics and Class A limit line European Limits

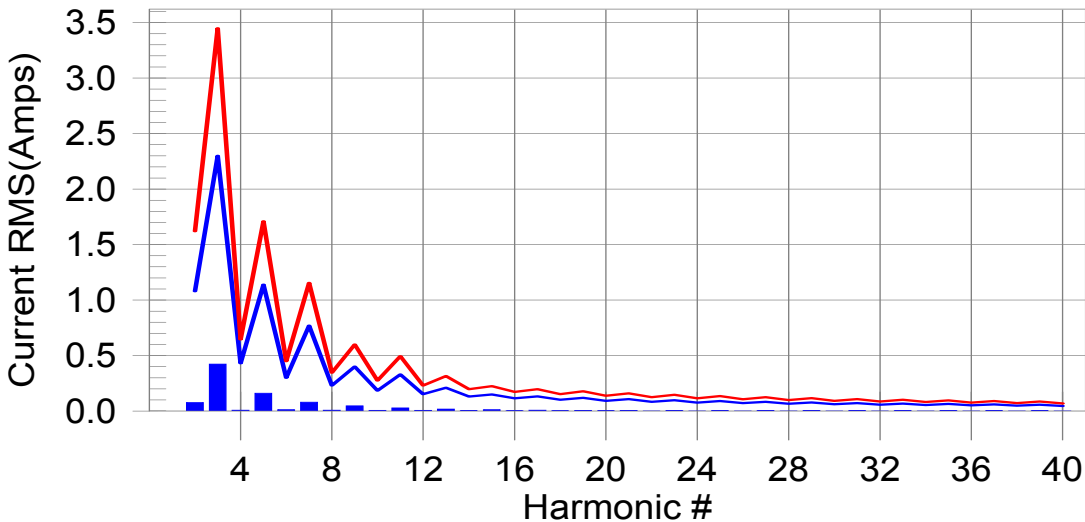

**Test result: Pass** **Worst harmonic was #3 with 18.4% of the limit.**

### Current Test Result Summary (Run time)

EUT: X1-AC(X1-AC-3.6) Tested by: J  
 Test category: Class-A per Ed. 4.0 (2014) (European limits) Test Margin: 100  
 Test date: 2018/8/30 Start time: 15:07:07 End time: 15:09:58  
 Test duration (min): 2.5 Data file name: H-000460.cts\_data  
 Comment: ON  
 Customer: SOLAX

Test Result: Pass Source qualification: Normal  
 THC(A): 0.471 I-THD(%): 7.3 POHC(A): 0.000 POHC Limit(A): 0.251

Highest parameter values during test:

V\_RMS (Volts): 219.72 Frequency(Hz): 50.00  
 I\_Peak (Amps): 10.471 I\_RMS (Amps): 6.716  
 I\_Fund (Amps): 6.684 Crest Factor: 4.527  
 Power (Watts): 1467.7 Power Factor: 0.997

Harm#	Harms(avg)	100%Limit	%of Limit	Harms(max)	150%Limit	%of Limit	Status
2	0.078	1.080	7.2	0.082	1.620	5.1	Pass
3	0.423	2.300	18.4	0.440	3.450	12.7	Pass
4	0.008	0.430	N/A	0.014	0.645	N/A	Pass
5	0.161	1.140	14.1	0.169	1.710	9.9	Pass
6	0.012	0.300	N/A	0.014	0.450	N/A	Pass
7	0.081	0.770	10.5	0.086	1.155	7.4	Pass
8	0.008	0.230	N/A	0.010	0.345	N/A	Pass
9	0.047	0.400	11.7	0.051	0.600	8.4	Pass
10	0.007	0.184	N/A	0.009	0.276	N/A	Pass
11	0.029	0.330	N/A	0.032	0.495	N/A	Pass
12	0.006	0.153	N/A	0.008	0.230	N/A	Pass
13	0.018	0.210	N/A	0.020	0.315	N/A	Pass
14	0.004	0.131	N/A	0.005	0.197	N/A	Pass
15	0.012	0.150	N/A	0.013	0.225	N/A	Pass
16	0.003	0.115	N/A	0.004	0.173	N/A	Pass
17	0.009	0.132	N/A	0.011	0.198	N/A	Pass
18	0.002	0.102	N/A	0.003	0.153	N/A	Pass
19	0.006	0.118	N/A	0.009	0.178	N/A	Pass
20	0.002	0.092	N/A	0.003	0.138	N/A	Pass
21	0.005	0.107	N/A	0.009	0.161	N/A	Pass
22	0.002	0.084	N/A	0.002	0.125	N/A	Pass
23	0.005	0.098	N/A	0.008	0.147	N/A	Pass
24	0.002	0.077	N/A	0.002	0.115	N/A	Pass
25	0.005	0.090	N/A	0.008	0.135	N/A	Pass
26	0.001	0.071	N/A	0.002	0.107	N/A	Pass
27	0.004	0.083	N/A	0.008	0.125	N/A	Pass
28	0.002	0.066	N/A	0.002	0.099	N/A	Pass
29	0.004	0.078	N/A	0.007	0.116	N/A	Pass
30	0.001	0.061	N/A	0.002	0.092	N/A	Pass
31	0.004	0.073	N/A	0.007	0.109	N/A	Pass
32	0.001	0.058	N/A	0.002	0.086	N/A	Pass
33	0.005	0.068	N/A	0.006	0.102	N/A	Pass
34	0.001	0.054	N/A	0.002	0.081	N/A	Pass
35	0.005	0.064	N/A	0.006	0.096	N/A	Pass
36	0.002	0.051	N/A	0.002	0.077	N/A	Pass
37	0.005	0.061	N/A	0.005	0.091	N/A	Pass
38	0.001	0.048	N/A	0.001	0.073	N/A	Pass
39	0.005	0.058	N/A	0.006	0.087	N/A	Pass
40	0.002	0.046	N/A	0.002	0.069	N/A	Pass

**Voltage Source Verification Data (Run time)**

EUT: X1-AC(X1-AC-3.6) Tested by: J  
 Test category: Class-A per Ed. 4.0 (2014) (European limits) Test Margin: 100  
 Test date: 2018/8/30 Start time: 15:07:07 End time: 15:09:58  
 Test duration (min): 2.5 Data file name: H-000460.cts\_data  
 Comment: ON  
 Customer: SOLAX

**Test Result: Pass Source qualification: Normal**

**Highest parameter values during test:**

Voltage (Vrms): 219.72 Frequency(Hz): 50.00  
 I\_Peak (Amps): 10.471 I\_RMS (Amps): 6.716  
 I\_Fund (Amps): 6.684 Crest Factor: 4.527  
 Power (Watts): 1467.7 Power Factor: 0.997

Harm#	Harmonics V-rms	Limit V-rms	% of Limit	Status
2	0.074	0.439	16.87	OK
3	0.670	1.977	33.87	OK
4	0.055	0.439	12.50	OK
5	0.106	0.878	12.08	OK
6	0.044	0.439	10.11	OK
7	0.031	0.659	4.70	OK
8	0.023	0.439	5.27	OK
9	0.045	0.439	10.27	OK
10	0.020	0.439	4.47	OK
11	0.035	0.220	16.11	OK
12	0.017	0.220	7.77	OK
13	0.020	0.220	9.01	OK
14	0.007	0.220	3.18	OK
15	0.016	0.220	7.39	OK
16	0.016	0.220	7.40	OK
17	0.012	0.220	5.26	OK
18	0.015	0.220	6.71	OK
19	0.008	0.220	3.79	OK
20	0.013	0.220	5.92	OK
21	0.008	0.220	3.54	OK
22	0.003	0.220	1.52	OK
23	0.008	0.220	3.53	OK
24	0.005	0.220	2.42	OK
25	0.008	0.220	3.78	OK
26	0.002	0.220	0.94	OK
27	0.006	0.220	2.93	OK
28	0.004	0.220	1.99	OK
29	0.006	0.220	2.51	OK
30	0.004	0.220	1.71	OK
31	0.009	0.220	3.95	OK
32	0.004	0.220	1.61	OK
33	0.007	0.220	2.99	OK
34	0.003	0.220	1.47	OK
35	0.008	0.220	3.72	OK
36	0.003	0.220	1.33	OK
37	0.006	0.220	2.56	OK
38	0.003	0.220	1.17	OK
39	0.010	0.220	4.65	OK
40	0.006	0.220	2.63	OK

**Harmonics – Per EN/IEC61000-3-12(Run time)**

EUT: X1-AC(X1-AC-5.0)  
Test category: Table:2,  
Test date: 2018/9/30  
Test duration (min): 2.5  
Comment: ON  
Customer: SOLAX

Tested by: LQZ  
Rsce=33, Inter-Harm,  
Start time: 11:41:36  
Data file name: WIN2106\_H-000165.cts\_data

Test Margin: 100  
End time: 11:44:28

Test Result: Pass

Source qualification: Normal

Current & voltage waveforms

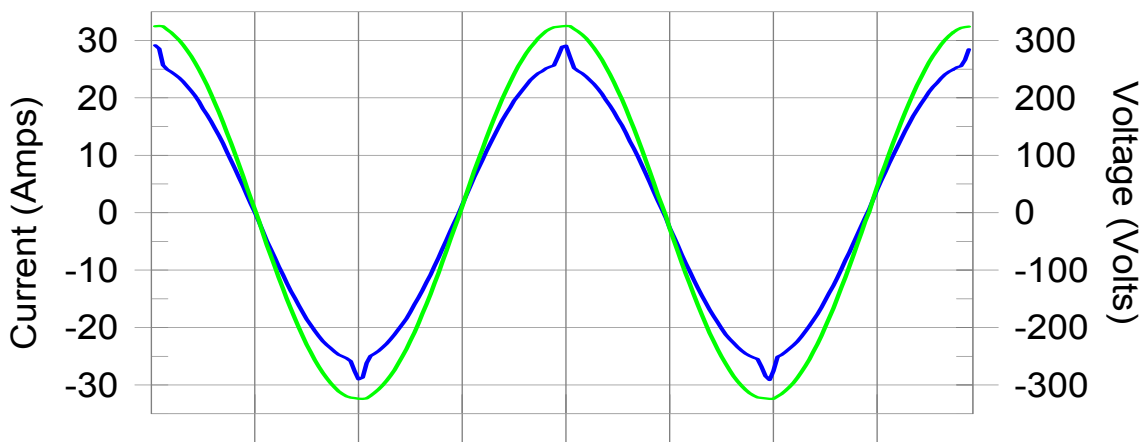

Harmonics and Class 2 limit line

European Limits

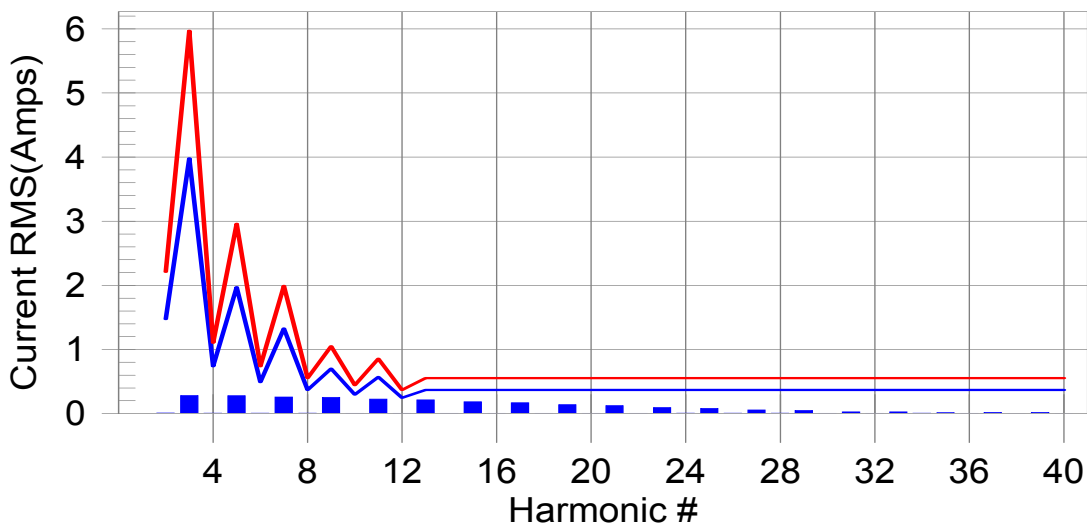

Test result: Pass

Worst harmonic was #13 with 59.28 % of the limit.

### Current Test Result Summary (Run time)

EUT: X1-AC(X1-AC-5.0) Tested by: LQZ  
 Test category: Table:2, Rsc=33, Inter-Harm, Test Margin: 100  
 Test date: 2018/9/30 Start time: 11:41:36 End time: 11:44:28  
 Test duration (min): 2.5 Data file name: WIN2106\_H-000165.cts\_data  
 Comment: ON  
 Customer: SOLAX

Test Result: Pass Measured I-ref: 18.418 Amp rms Source: Normal  
 I-THC(%): 3.9 Limit(%): 23.0 PWHC(%): 8.3 PWHC Limit(%): 23.0

Highest parameter values during test:

V\_RMS (Volts): 229.78 Frequency(Hz): 50.00  
 I\_Peak (Amps): 54.865 I\_RMS (Amps): 18.732  
 I\_Fund (Amps): 18.418 Crest Factor: 2.932  
 Power (Watts): 4278 Power Factor: 0.999

Harm#	Harms(avg)	100%Limit	%of Limit	Harms(max)	150%Limit	%of Limit	Status
2	0.009	1.475	0.6	0.072	2.212	3.3	Pass
3	0.282	3.981	7.1	0.351	5.972	5.9	Pass
4	0.007	0.737	1.0	0.089	1.106	8.1	Pass
5	0.279	1.972	14.1	0.335	2.958	11.3	Pass
6	0.006	0.492	1.3	0.080	0.737	10.9	Pass
7	0.259	1.327	19.5	0.306	1.991	15.4	Pass
8	0.006	0.369	1.7	0.070	0.553	12.6	Pass
9	0.254	0.700	36.3	0.290	1.051	27.6	Pass
10	0.005	0.295	1.8	0.057	0.442	13.0	Pass
11	0.226	0.571	39.5	0.252	0.857	29.4	Pass
12	0.005	0.246	2.1	0.045	0.369	12.3	Pass
13	0.214	0.369	57.9	0.230	0.553	41.7	Pass
14	0.004	N/A	N/A	0.033	N/A	N/A	N/A
15	0.184	N/A	N/A	0.195	N/A	N/A	N/A
16	0.004	N/A	N/A	0.022	N/A	N/A	N/A
17	0.168	N/A	N/A	0.173	N/A	N/A	N/A
18	0.004	N/A	N/A	0.014	N/A	N/A	N/A
19	0.139	N/A	N/A	0.142	N/A	N/A	N/A
20	0.005	N/A	N/A	0.009	N/A	N/A	N/A
21	0.123	N/A	N/A	0.126	N/A	N/A	N/A
22	0.004	N/A	N/A	0.007	N/A	N/A	N/A
23	0.095	N/A	N/A	0.097	N/A	N/A	N/A
24	0.006	N/A	N/A	0.010	N/A	N/A	N/A
25	0.082	N/A	N/A	0.084	N/A	N/A	N/A
26	0.007	N/A	N/A	0.010	N/A	N/A	N/A
27	0.056	N/A	N/A	0.057	N/A	N/A	N/A
28	0.007	N/A	N/A	0.010	N/A	N/A	N/A
29	0.049	N/A	N/A	0.049	N/A	N/A	N/A
30	0.005	N/A	N/A	0.008	N/A	N/A	N/A
31	0.028	N/A	N/A	0.029	N/A	N/A	N/A
32	0.005	N/A	N/A	0.008	N/A	N/A	N/A
33	0.026	N/A	N/A	0.027	N/A	N/A	N/A
34	0.006	N/A	N/A	0.008	N/A	N/A	N/A
35	0.015	N/A	N/A	0.016	N/A	N/A	N/A
36	0.004	N/A	N/A	0.005	N/A	N/A	N/A
37	0.019	N/A	N/A	0.020	N/A	N/A	N/A
38	0.002	N/A	N/A	0.004	N/A	N/A	N/A
39	0.018	N/A	N/A	0.020	N/A	N/A	N/A
40	0.002	N/A	N/A	0.003	N/A	N/A	N/A

Note: Measured I-ref was applied for this test.



## 7. VOLTAGE FLUCTUATION AND FLICKER MEASUREMENT

### 7.1. Block Diagram of Test Setup

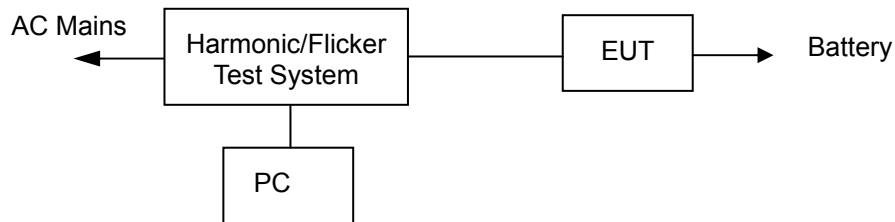

(EUT: X1-AC)

### 7.2. Measuring Standard

EN 61000-3-11:2000  
EN 61000-3-3:2013

### 7.3. Operation Condition of EUT

7.3.1. Turn on the power.

7.3.2. After that, let the EUT work in test mode (ON) and measure it.

### 7.4. Measuring Results

**PASS.**

Please refer to the following pages.

(Model X1-AC-5.0 tests were carried out at: EMTEK (SHENZHEN) CO., LTD. The Certificate Registration Number is L2291, Accredited by CNAS, 2016.10.24, The certificate is valid until 2022.10.28)



**Flicker Test Summary per EN/IEC61000-3-3 (Run time)**

EUT: X1-AC(X1-AC-3.6) Tested by: J  
 Test category: dt,dmax,dc and Pst (European limits) Test Margin: 100  
 Test date: 2018/8/30 Start time: 15:12:01 End time: 15:22:32  
 Test duration (min): 10 Data file name: F-000461.cts\_data  
 Comment: ON  
 Customer: SOLAX

**Test Result: Pass**                      **Status: Test Completed**

**Pst, and limit line** **European Limits**

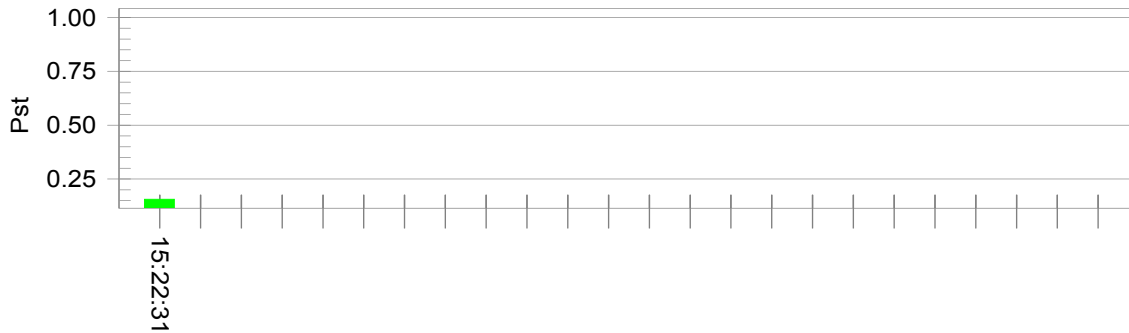

**Plt and limit line**



**Parameter values recorded during the test:**

Vrms at the end of test (Volt):	216.10		
Highest dt (%):	0.00	Test limit (%):	N/A      N/A
T-max (mS):	0	Test limit (mS):	500.0    Pass
Highest dc (%):	0.00	Test limit (%):	3.30     Pass
Highest dmax (%):	0.45	Test limit (%):	4.00     Pass
Highest Pst (10 min. period):	0.156	Test limit:	1.000    Pass

**Flicker Test Summary (Run time) per EN/IEC61000-3-11**

EUT: X1-AC(X1-AC-5.0) Tested by: LQZ  
 Test category: All parameters Test Margin: 100  
 Test date: 2018/9/30 Start time: 16:08:55 End time: 16:19:26  
 Test duration (min): 10 Data file name: WIN2106\_F-000116.cts\_data  
 Comment: ON  
 Customer: SOLAX  
 Z-test = (0.400 + j 0.250 Ohm)

Test Result: Pass  
 Status: Test Completed

**Pst<sub>i</sub> and limit line**

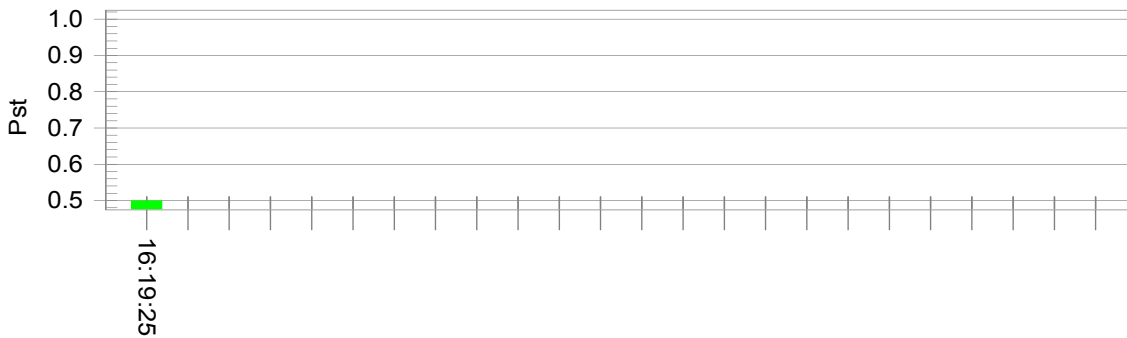

**Plt and limit line**

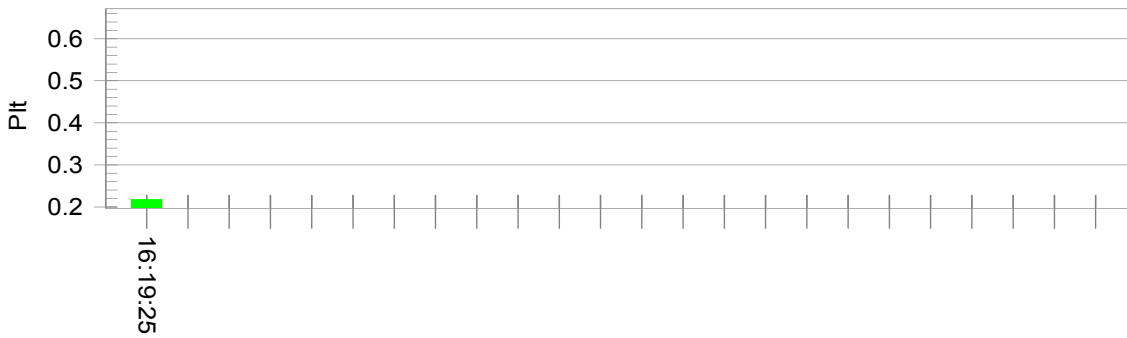

**Parameter values recorded during the test:**

Vrms at the end of test (Volt): 229.18

T-max (mS):	0.0	Test limit (mS):	500.0	Pass
Highest dc (%):	0.00	Test limit (%):	3.30	Pass
Highest dmax (%):	0.94	Test limit (%):	4.00	Pass
Highest Pst (10 min. period):	0.499	Test limit:	1.000	Pass
Highest Plt (2 hr. period):	0.218	Test limit:	0.650	Pass

Calculated dmax(%): 0.936  
 Calculated dc(%): 0.000  
 Calculated Pst : 0.499

**Calculated Plt : 0.218**

**The maximum permissible system impedance Zsys:**

$$Z = 1.133 \text{ Ohm} + j 0.708 \text{ Ohm} \quad (1.133 \text{ Ohm} + 2255 \text{ ?H})$$

## 8. IMMUNITY PERFORMANCE CRITERIA DESCRIPTION

A functional description and a definition of performance criteria, during or as a consequence of the EMC testing, shall be provided by the manufacturer and noted in the test report, based on one of the following criteria:

**Performance criterion A:** The apparatus shall continue to operate as intended during and after the test. No degradation of performance or loss of function is allowed below a performance level specified by the manufacturer, when the apparatus is used as intended. The performance level may be replaced by a permissible loss of performance. If the minimum performance level or the permissible performance loss is not specified by the manufacturer, either of these may be derived from the product description and documentation and what the user may reasonably expect from the apparatus if used as intended.

**Performance criterion B:** The apparatus shall continue to operate as intended after the test. No degradation of performance or loss of function is allowed below a performance level specified by the manufacturer, when the apparatus is used as intended. The performance level may be replaced by a permissible loss of performance. During the test, degradation of performance is however allowed. No change of actual operating state or stored data is allowed. If the minimum performance level or the permissible performance loss is not specified by the manufacturer, either of these may be derived from the product description and documentation and what the user may reasonably expect from the apparatus if used as intended.

**Performance criterion C:** Temporary loss of function is allowed, provided the function is self-recoverable or can be restored by the operation of the controls.

## 9. ELECTROSTATIC DISCHARGE IMMUNITY TEST

### 9.1. Block Diagram of Test Setup

9.1.1. Block diagram of connection between the EUT and simulators

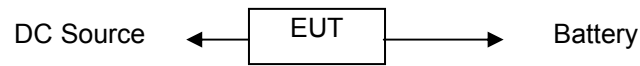

(EUT: X1-AC)

9.1.2. Block diagram of ESD test setup

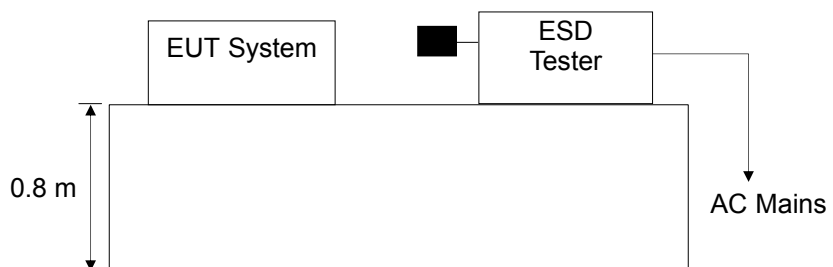

(EUT: X1-AC)

### 9.2. Test Standard

EN 61000-6-1:2007, EN 61000-6-2:2005  
(IEC 61000-4-2:2008 Severity Level: 3 / Air Discharge:  $\pm 8\text{kV}$   
Level: 2 / Contact Discharge:  $\pm 4\text{kV}$ )

### 9.3. Severity Levels and Performance Criterion

9.3.1. Severity level

Level	Test Voltage Contact Discharge (kV)	Test Voltage Air Discharge (kV)
1	$\pm 2$	$\pm 2$
2	$\pm 4$	$\pm 4$
3	$\pm 6$	$\pm 8$
4	$\pm 8$	$\pm 15$
X	Special	Special

9.3.2. Performance criterion: **B**

## 9.4. Operating Condition of EUT

9.4.1. Turn on the power.

9.4.2. After that, let the EUT work in test mode (Charging, Discharging) and measure it.

## 9.5. Test Procedure

9.5.1. Air Discharge:

This test is done on a non-conductive surface. The round discharge tip of the discharge electrode shall be approached as fast as possible to touch the EUT. After each discharge, the discharge electrode shall be removed from the EUT. The generator is then re-triggered for a new single discharge and repeated 10 times for each pre-selected test point. This procedure shall be repeated until all the air discharge completed.

9.5.2. Contact Discharge:

All the procedure shall be same as section 9.5.1. Except that the tip of the discharge electrode shall touch the EUT before the discharge switch is operated.

9.5.3. Indirect discharge for horizontal coupling plane

At least 10 single discharges (in the most sensitive polarity) shall be applied at the front edge of each HCP opposite the center point of each unit (if applicable) of the EUT and 0.1m from the front of the EUT. The long axis of the discharge electrode shall be in the plane of the HCP and perpendicular to its front edge during the discharge.

9.5.4. Indirect discharge for vertical coupling plane

At least 10 singles discharge (in the most sensitive polarity) shall be applied to the center of one vertical edge of the coupling plane. The coupling plane, of dimensions 0.5m×0.5m, is placed parallel to, and positioned at a distance of 0.1m from the EUT. Discharges shall be applied to the coupling plane, with this plane in sufficient different positions that the four faces of the EUT are completely illuminated.

## 9.6. Test Results

**PASS.**

Please refer to the following page.

## Electrostatic Discharge Test Result

Reference Standard: <input checked="" type="checkbox"/> IEC 61000-4-2	Test Result: <input checked="" type="checkbox"/> PASS/ <input type="checkbox"/> FAIL	
Applicant : <u>SOLAX POWER NETWORK TECHNOLOGY(ZHEJIANG) CO., LTD.</u>		
EUT : <u>X1-AC</u>	Test Date : <u>September 30, 2018</u>	
M/N : <u>X1-AC-5.0</u>	Temperature : <u>25°C</u>	
Input Voltage : <u>AC 230V/50Hz</u>	Humidity : <u>49%</u>	
Air discharge : <u>± 8.0KV</u>	Test Mode : <u>Charging, Discharging</u>	
Contact discharge : <u>± 4.0KV</u>	Criterion : <u>B</u>	
Test Engineer : <u>LQI</u>		
	<b>Kind</b>	
<b>Location</b>	A-Air Discharge C-Contact Discharge	<b>Result</b>
HCP	C	A
VCP	C	A
Metal	C	A
Screw&Power	C	A
Slot%creen	A	A
/	/	/
Note:		

## 10. RF FIELD STRENGTH SUSCEPTIBILITY TEST

### 10.1. Block Diagram of Test Setup

#### 10.1.1. Block diagram of connection between the EUT and simulators

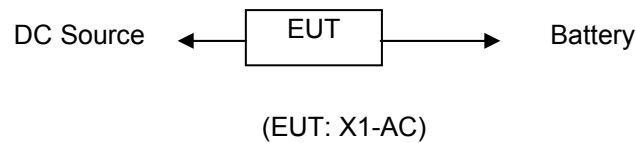

#### 10.1.2. Block diagram of RS test setup

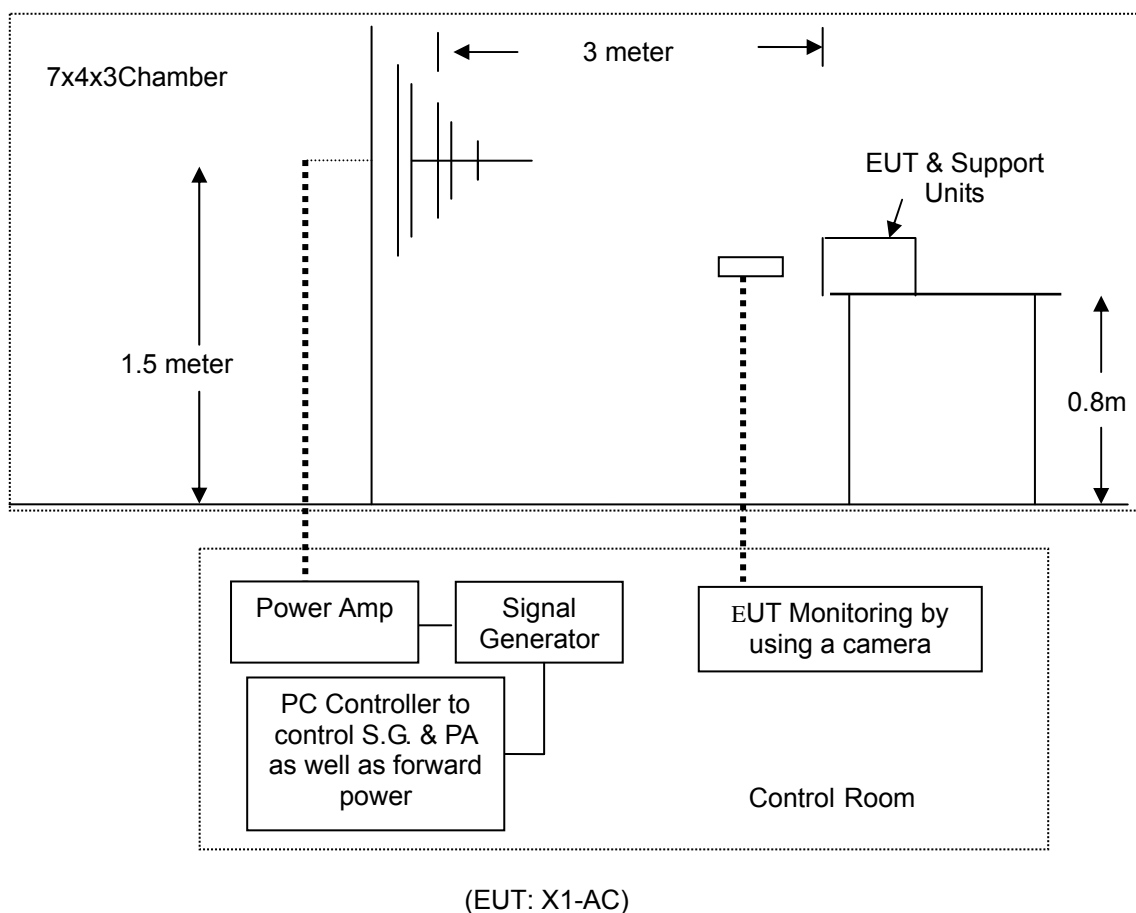

### 10.2. Test Standard

EN 61000-6-1:2007

(IEC 61000-4-3:2006+A1:2007+A2:2010, Severity Level: 80M~1000MHz, 3V/m; 1.4G~2.0GHz, 3V/m; 2.0G~2.7GHz, 1V/m)

EN 61000-6-2:2005

(IEC 61000-4-3:2006+A1:2007+A2:2010, Severity Level: 80M~1000MHz, 10V/m; 1.4G~2.0GHz, 3V/m; 2.0G~2.7GHz, 1V/m)



### 10.3. Severity Levels and Performance Criterion

#### 10.3.1. Severity Levels

Level	Field Strength V/m
1.	1
2.	3
3.	10
X	Special

#### 10.3.2. Performance Criterion: A

### 10.4. Operating Condition of EUT

10.4.1. Turn on the power.

10.4.2. After that, let the EUT work in test mode (Charging, Discharging) and measure it.

### 10.5. Test Procedure

The EUT are placed on a table that is 0.8 meter high above the ground. The EUT is set 3 meters away from the transmitting antenna that is mounted on an antenna tower. Both horizontal and vertical polarization of the antenna is set on test. Each of the four sides of the EUT must be faced this transmitting antenna and measured individually. In order to judge the EUT performance, a CCD camera is used to monitor it.

All the scanning conditions are as following:

Condition of Test	Remark
1. Fielded Strength	1V/m, 3V/m, 10V/m
2. Radiated Signal	Modulated
3. Scanning Frequency	80-2700MHz
4. Sweep time of radiated	0.0015 Decade/s
5. Dwell Time	1 Sec.

### 10.6. Test Results

**PASS.**

Please refer to the following page.

(The tests were carried out at: EMTEK (SHENZHEN) CO., LTD. The Certificate Registration Number is L2291, Accredited by CNAS, 2016.10.24, The certificate is valid until 2022.10.28)

# RF Field Strength Susceptibility Test Results

EN 61000-6-1

Reference Standard: <input checked="" type="checkbox"/> IEC 61000-4-3		Test Result: <input checked="" type="checkbox"/> PASS/ <input type="checkbox"/> FAIL				
Applicant : <u>SOLAX POWER NETWORK TECHNOLOGY(ZHEJIANG) CO., LTD.</u>						
EUT : <u>X1-AC</u>		Test Date : <u>September 30, 2018</u>				
M/N : <u>X1-AC-5.0</u>		Temperature : <u>26.2°C</u>				
Field Strength : 80M~1000MHz, 3V/m; 1.4G~2.0GHz, 3V/m; 2.0G~2.7GHz, 1V/m		Humidity : <u>49%</u>				
Input Voltage : <u>AC 230V/50Hz</u>		Criterion : <u>A</u>				
Test Mode : <u>Charging, Discharging</u>		Frequency Range : <u>80MHz to 2700MHz</u>				
Test Engineer : <u>LQI</u>						
Modulation:	<input type="checkbox"/> None		<input type="checkbox"/> Pulse		<input checked="" type="checkbox"/> AM 1KHz 80%	
	Frequency Rang 1: 80~ 1000MHz		Frequency Rang 2: 1.4~2.0GHz		Frequency Rang 3: 2.0~2.7GHz	
	Steps: 1%		Steps: 1%		Steps: 1%	
	Horizontal	Vertical	Horizontal	Vertical	Horizontal	Vertical
Front	A	A	A	A	A	A
Right	A	A	A	A	A	A
Rear	A	A	A	A	A	A
Left	A	A	A	A	A	A
Test Equipment: 1. Signal Generator: Agilent;N5181A 2. Power Amplifier: MILMEGA; 80RF1000-175; MILMEGA;AS0102-55; MILMEGA;AS1860-50 3. Log.-Per.Antenna: SCHWARZBECK: VULP 9118E Broad-Band Horn Antenna: SCHWARZBECK; STLP 9149 4. RF Power Meter. Field Monitor: DARE;RSS1006A						
Note:						

# RF Field Strength Susceptibility Test Results

EN 61000-6-2

Reference Standard: <input checked="" type="checkbox"/> IEC 61000-4-3		Test Result: <input checked="" type="checkbox"/> PASS/ <input type="checkbox"/> FAIL				
Applicant : <u>SOLAX POWER NETWORK TECHNOLOGY(ZHEJIANG) CO., LTD.</u>						
EUT : <u>X1-AC</u>		Test Date : <u>September 30, 2018</u>				
M/N : <u>X1-AC-5.0</u>		Temperature : <u>26.2°C</u>				
Field Strength : 80M~1000MHz, 10V/m; 1.4G~2.0GHz, 3V/m; 2.0G~2.7GHz, 1V/m		Humidity : <u>49%</u>				
Input Voltage : <u>AC 230V/50Hz</u>		Criterion : <u>A</u>				
Test Mode : <u>Charging, Discharging</u>		Frequency Range : <u>80MHz to 2700MHz</u>				
Test Engineer : <u>LQI</u>						
Modulation:	<input type="checkbox"/> None		<input type="checkbox"/> Pulse		<input checked="" type="checkbox"/> AM 1KHz 80%	
	Frequency Rang 1: 80~ 1000MHz		Frequency Rang 2: 1.4~2.0GHz		Frequency Rang 3: 2.0~2.7GHz	
	Steps: 1%		Steps: 1%		Steps: 1%	
	Horizontal	Vertical	Horizontal	Vertical	Horizontal	Vertical
Front	A	A	A	A	A	A
Right	A	A	A	A	A	A
Rear	A	A	A	A	A	A
Left	A	A	A	A	A	A
Test Equipment: 1. Signal Generator: Agilent;N5181A 2. Power Amplifier: MILMEGA; 80RF1000-175; MILMEGA;AS0102-55; MILMEGA;AS1860-50 3. Log.-Per.Antenna: SCHWARZBECK: VULP 9118E Broad-Band Horn Antenna: SCHWARZBECK; STLP 9149 4. RF Power Meter. Field Monitor: DARE;RSS1006A						
Note:						

## 11. ELECTRICAL FAST TRANSIENT/BURST IMMUNITY TEST

### 11.1. Block Diagram of Test Setup

#### 11.1.1. Block Diagram of the EUT

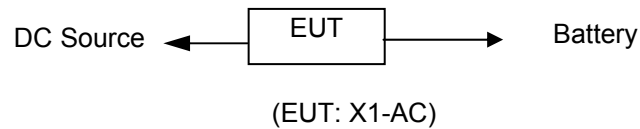

#### 11.1.2. EFT Test Setup

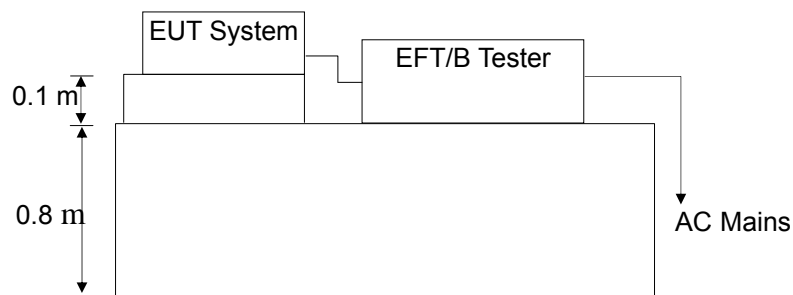

### 11.2. Test Standard

EN 61000-6-1:2007  
(IEC 61000-4-4:2012, Severity Level: DC power ports, 0.5KV; AC power ports, 1.0KV)  
EN 61000-6-2:2005  
(IEC 61000-4-4:2012, Severity Level: DC power ports, 2.0KV; AC power ports, 2.0KV)

### 11.3. Severity Levels and Performance Criterion

#### 11.3.1. Severity level

Level	Open Circuit Output Test Voltage $\pm 10\%$	
	On Power Supply Lines	On I/O (Input/Output) Signal data and control lines
1	0.5 kV	0.25 kV
2	1 kV	0.5 kV
3	2 kV	1 kV
4	4 kV	2 kV
X	Special	Special

#### 11.3.2. Performance criterion: **B**

## 11.4. Operating Condition of EUT

11.4.1. Turn on the power.

11.4.2. After that, let the EUT work in test mode (Charging, Discharging) and measure it.

## 11.5. Test Procedure

The EUT is put on the table that is 0.8 meter high above the ground. This reference ground plane shall project beyond the EUT by at least 0.1m on all sides and the minimum distance between EUT and all other conductive structure, except the ground plane beneath the EUT, shall be more than 0.5m.

11.5.1. For input and output AC power ports:

The AC output power ports of EUT are connected to the AC power mains by using a coupling device that couples the EFT interference signal to AC power lines (AC Output Power Ports). All of the test voltage should be applied during compliance test and the duration of the test is 2 mins.

11.5.2. For signal lines and control lines ports:

It's unnecessary to test.

11.5.3. For input and output DC power ports:

It's unnecessary to test.

## 11.6. Test Result

**PASS.**

Please refer to the following page.

(The tests were carried out at: EMTEK (SHENZHEN) CO., LTD. The Certificate Registration Number is L2291, Accredited by CNAS, 2016.10.24, The certificate is valid until 2022.10.28)

## Electrical Fast Transient/Burst Test Results

Reference Standard: <input checked="" type="checkbox"/> IEC 61000-4-4		Test Result: <input checked="" type="checkbox"/> PASS/ <input type="checkbox"/> FAIL	
Applicant : <u>SOLAX POWER NETWORK TECHNOLOGY(ZHEJIANG) CO., LTD.</u>			
EUT : <u>X1-AC</u>		Test Date : <u>September 30, 2018</u>	
M/N : <u>X1-AC-5.0</u>		Temperature : <u>26.4°C</u>	
Input Voltage : <u>AC 230V/50Hz</u>		Humidity : <u>45%</u>	
Test Mode : <u>Charging, Discharging</u>		Criterion : <u>B</u>	
Test Engineer : <u>LQI</u>			
Line : <input checked="" type="checkbox"/> AC Output line <input type="checkbox"/> DC Input lines		Line : <input type="checkbox"/> Signal <input type="checkbox"/> I/O Cable	
Coupling : <input checked="" type="checkbox"/> Direct		Coupling : <input type="checkbox"/> Capacitive	
Test Time : 120s		Freq: 5kHz	
Line	Test Voltage	Result(+)	Result(-)
L	1.0KV, 2.0KV	A	A
N	1.0KV, 2.0KV	A	A
PE	1.0KV, 2.0KV	A	A
L、N	1.0KV, 2.0KV	A	A
L、PE	1.0KV, 2.0KV	A	A
N、PE	1.0KV, 2.0KV	A	A
L、N、PE	1.0KV, 2.0KV	A	A
/	/	/	/
Note: /			
Test Equipment: /			

## 12. SURGE IMMUNITY TEST

### 12.1. Block Diagram of Test Setup

#### 12.1.1. Block Diagram of the EUT



#### 12.1.2. Surge Test Setup

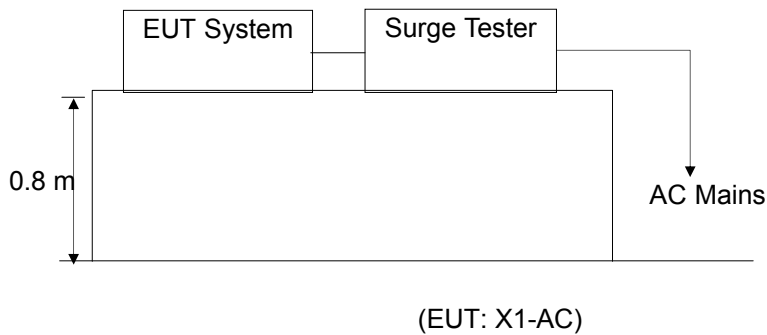

## 12.2. Test Standard

EN 61000-6-1:2007, EN 61000-6-2:2005  
(IEC 61000-4-5:2014, Severity Level: Line to Line/1.0KV, Line to Earth/2.0KV)

## 12.3. Severity Levels and Performance Criterion

#### 12.3.1. Severity level

Severity Level	Open-Circuit Test Voltage kV
1	0.5
2	1.0
3	2.0
4	4.0
*	Special

#### 12.3.2. Performance criterion: **B**

## 12.4. Operating Condition of EUT

12.4.1. Turn on the power.

12.4.2. After that, let the EUT work in test mode (Charging, Discharging) and measure it.

## 12.5. Test Procedure

- 1) Set up the EUT and test generator as shown on Section 12.1.2.
- 2) For line to line coupling mode, provide a 0.5/1.0 KV 1.2/50us voltage surge. For line to earth coupling mode, provide a 2.0 KV 1.2/50us voltage surge. (At open-circuit condition) and 8/20us current surge to EUT selected points.
- 3) At least 5 positive and 5 negative (polarity) tests with a maximum 1/min repetition rate are conducted during test.
- 4) Different phase angles are done individually.
- 5) Record the EUT operating situation during compliance test and decide the EUT immunity criterion for above each test.

## 12.6. Test Result

**PASS.**

Please refer to the following page.

(The tests were carried out at: EMTEK (SHENZHEN) CO., LTD. The Certificate Registration Number is L2291, Accredited by CNAS, 2016.10.24, The certificate is valid until 2022.10.28)



## Surge Immunity Test Result

Reference Standard: <input checked="" type="checkbox"/> IEC 61000-4-5	Test Result: <input checked="" type="checkbox"/> PASS/ <input type="checkbox"/> FAIL				
<p>Applicant : <u>SOLAX POWER NETWORK TECHNOLOGY(ZHEJIANG) CO., LTD.</u></p> <p>EUT : <u>X1-AC</u> Test Date : <u>September 30, 2018</u></p> <p>M/N : <u>X1-AC-5.0</u> Temperature : <u>26.4°C</u></p> <p>Input Voltage : <u>AC 230V/50Hz</u> Humidity : <u>45%</u></p> <p>Test Mode : <u>Charging, Discharging</u> Criterion : <u>B</u></p> <p>Test Engineer : <u>LQI</u></p>					
Location	Polarity	Phase Angle	Number of Pulse	Pulse Voltage (KV)	Result
L-N	+	0°	5	1.0	A
	+	90°	5	1.0	A
	+	180°	5	1.0	A
	+	270°	5	1.0	A
	-	0°	5	1.0	A
	-	90°	5	1.0	A
	-	180°	5	1.0	A
	-	270°	5	1.0	A
L-PE	+	0°	5	2.0	A
	+	90°	5	2.0	A
	+	180°	5	2.0	A
	+	270°	5	2.0	A
	-	0°	5	2.0	A
	-	90°	5	2.0	A
	-	180°	5	2.0	A
	-	270°	5	2.0	A
N-PE	+	0°	5	2.0	A
	+	90°	5	2.0	A
	+	180°	5	2.0	A
	+	270°	5	2.0	A
	-	0°	5	2.0	A
	-	90°	5	2.0	A
	-	180°	5	2.0	A
	-	270°	5	2.0	A
Note:					

## 13. INJECTED CURRENTS SUSCEPTIBILITY TEST

### 13.1. Block Diagram of Test Setup

#### 13.1.1. Block Diagram of the EUT

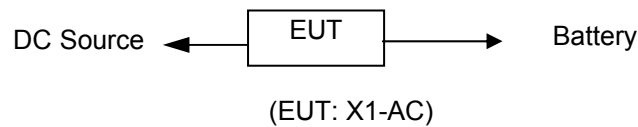

#### 13.1.2. Block Diagram of Test Setup

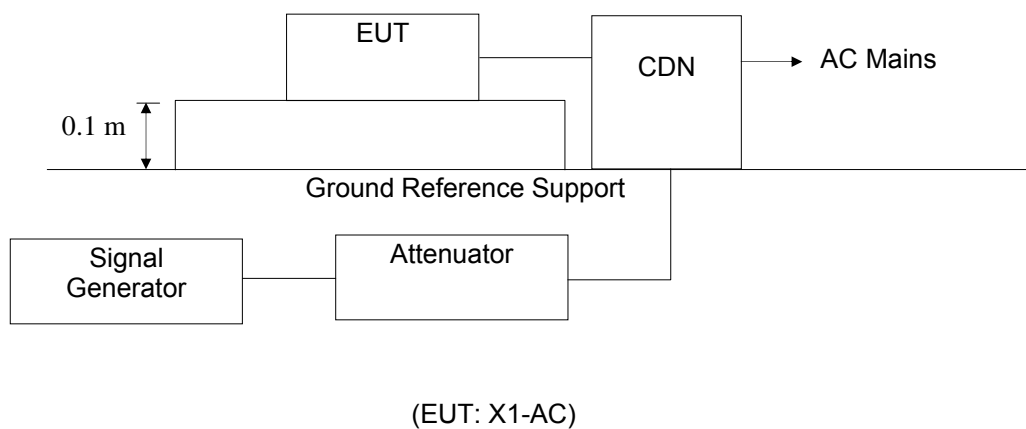

### 13.2. Test Standard

EN 61000-6-1:2007(IEC 61000-4-6:2013, Severity Level: 3V (r.m.s.), 0.15MHz ~ 80MHz)  
EN 61000-6-2:2005(IEC 61000-4-6:2013, Severity Level: 10V (r.m.s.), 0.15MHz ~ 80MHz)

### 13.3. Severity Levels and Performance Criterion

#### 13.3.1. Severity level

Level	Field Strength V
1	1
2	3
3	10
X	Special

#### 13.3.2. Performance criterion: **A**

### 13.4. Operating Condition of EUT

13.4.1. Turn on the power.

13.4.2. After that, let the EUT work in test mode (Charging, Discharging) and measure it.

### 13.5. Test Procedure

- 1) Set up the EUT, CDN and test generators as shown on Section 13.1.2.
- 2) Let the EUT work in test mode and measure it.
- 3) The EUT are placed on an insulating support 0.1m high above a ground reference plane. CDN (coupling and decoupling device) is placed on the ground plane about 0.3m from EUT. Cables between CDN and EUT are as short as possible, and their height above the ground reference plane shall be between 30 and 50 mm (where possible).
- 4) The EUT are placed on an insulating support 0.1m high above a ground reference plane. EM-Clamp is placed on the ground plane about 0.3m from EUT.
- 5) The disturbance signal described below is injected to EUT through CDN.
- 6) The EUT operates within its operational mode(s) under intended climatic conditions after power on.
- 7) The frequency range is swept from 150kHz to 80MHz using 3V and 10V signal level, and with the disturbance signal 80% amplitude modulated with a 1kHz sine wave.
- 8) The rate of sweep shall not exceed  $1.5 \times 10^{-3}$  decades/s. where the frequency is swept incrementally; the step size shall not exceed 1% of the start and thereafter 1% of the preceding frequency value.
- 9) Recording the EUT operating situation during compliance testing and decide the EUT immunity criterion.

### 13.6. Test Results

**PASS.**

Please refer to the following page.

(The tests were carried out at: EMTEK (SHENZHEN) CO., LTD. The Certificate Registration Number is L2291, Accredited by CNAS, 2016.10.24, The certificate is valid until 2022.10.28)

## Injected Currents Susceptibility Test Results

Reference Standard: <input checked="" type="checkbox"/> IEC 61000-4-6		Test Result: <input checked="" type="checkbox"/> PASS/ <input type="checkbox"/> FAIL		
Applicant : <u>SOLAX POWER NETWORK TECHNOLOGY(ZHEJIANG) CO., LTD.</u>				
EUT : <u>X1-AC</u>		Test Date : <u>September 30, 2018</u>		
M/N : <u>X1-AC-5.0</u>		Temperature : <u>26.4°C</u>		
Input Voltage : <u>AC 230V/50Hz</u>		Humidity : <u>45%</u>		
Test Engineer : <u>LQI</u>				
Test Mode: <u>Charging, Discharging</u>				
Frequency Range (MHz)	Injected Position	Strength (Unmodulated)	Criterion	Result
0.15 ~ 80	AC Output lines	3V, 10V	A	A
/	/	/	/	/
Test Mode : <u>Charging, Discharging</u>				
Frequency Range (MHz)	Injected Position	Strength (Unmodulated)	Criterion	Result
0.15~80	DC Input lines	3V, 10V	A	A
/	/	/	/	/
Remark : 1. Modulation Signal:1kHz 80% AM Measurement Equipment : Simulator: CWS 500C (SWITZERLAND EMTEST) CDN : <input type="checkbox"/> CDN-M2 (SWITZERLAND EMTEST) <input type="checkbox"/> CDN-M3 (SWITZERLAND EMTEST) <input type="checkbox"/> Injection Clamp (EMTEST F-2031-23MM) <input checked="" type="checkbox"/> CDN-M5332 (EMTEST)			Note:	

## 14. MAGNETIC FIELD SUSCEPTIBILITY TEST

### 14.1. Block Diagram of Test

#### 14.1.1. Magnetic field test setup

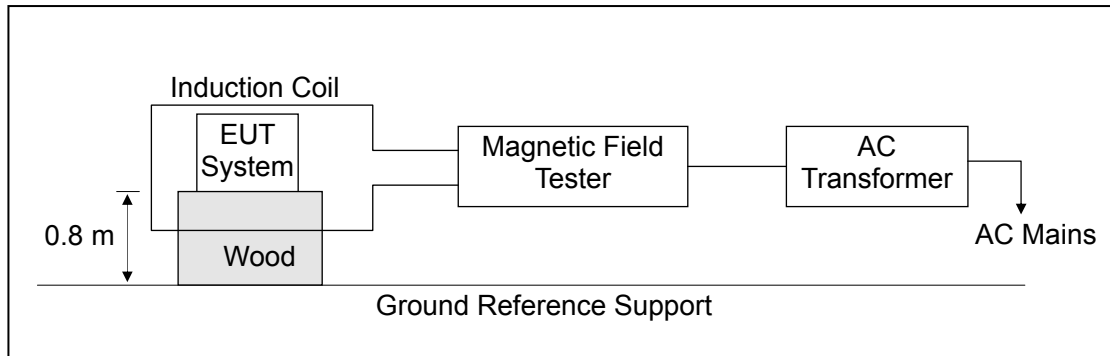

(EUT: X1-AC)

### 14.2. Test Standard

EN 61000-6-1:2007(IEC 61000-4-8:2009, Severity Level: Level 2, 3 A/m)  
EN 61000-6-2:2005(IEC 61000-4-8:2009, Severity Level: Level 4, 30 A/m)

### 14.3. Severity Levels and Performance Criterion

#### 14.3.1. Severity Levels

Level	Field Strength A/m
1	1
2	3
3	10
4	30
5	100
X	Special

#### 14.3.2. Performance Criterion: **A**

### 14.4. Operating Condition of EUT

Operating Condition of EUT are listed in section 14.5.

### 14.5. Test Procedure

The EUT is placed in the middle of a induction coil (1\*1m), under which is a 1\*1\*0.1m (high) table, this small table is also placed on a larger table, 0.8 m above the ground. Both horizontal and vertical polarization of the induction coil is set on test, so that each side of the EUT is affected by the magnetic field. Also can reach the same aim by change the position of the EUT.

#### 14.6. Test Results

**PASS.**

Please refer to the following page.

(The tests were carried out at: EMTEK (SHENZHEN) CO., LTD. The Certificate Registration Number is L2291, Accredited by CNAS, 2016.10.24, The certificate is valid until 2022.10.28)

## Magnetic Field Immunity Test Result

Standard: <input checked="" type="checkbox"/> IEC 61000-4-8		Result: <input checked="" type="checkbox"/> PASS / <input type="checkbox"/> FAIL		
Applicant : <u>SOLAX POWER NETWORK TECHNOLOGY(ZHEJIANG) CO., LTD.</u>				
EUT	: <u>X1-AC</u>	Test Date:	: <u>September 30, 2018</u>	
M/N	: <u>X1-AC-5.0</u>	Temperature	: <u>26.4°C</u>	
Input Voltage	: <u>AC 230V/50Hz</u>	Humidity	: <u>45%</u>	
Test Engineer	: <u>LQI</u>	Criterion	: <u>A</u>	
Operation Mode: <u>Charging, Discharging</u>				
Test Level (A/M)	Testing Duration	Coil Orientation	Criterion	Result
30	5 mins	X	A	A
30	5 mins	Y	A	A
30	5 mins	Z	A	A
Operation Mode: N/A				
Test Level (A/M)	Testing Duration	Coil Orientation	Criterion	Result
Test Equipment	Magnetic Field Test: HEAFELY MAG 100.1			
Note:				

## 15. VOLTAGE DIPS AND INTERRUPTIONS TEST

### 15.1. Block Diagram of Test Setup

#### 15.1.1. Block Diagram of the EUT.

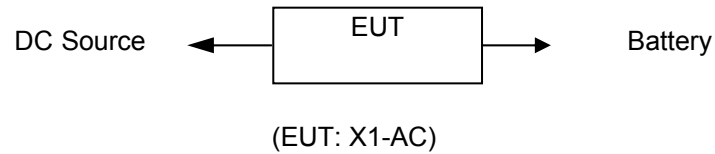

#### 15.1.2. Dips Test Setup

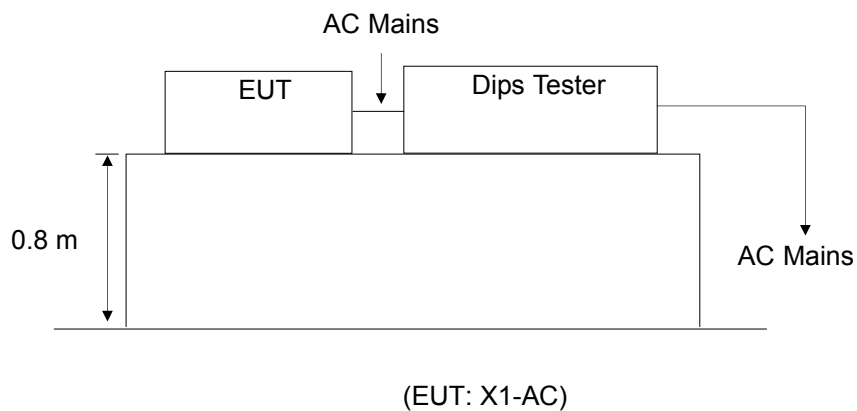

### 15.2. Test Standard

EN 61000-6-1:2007, EN 61000-6-2:2005 (IEC 61000-4-11:2004)

### 15.3. Severity Levels and Performance Criterion

#### 15.3.1. Severity level for EN61000-6-2

Test Level %UT	Voltage dip and short interruptions %UT	Duration (in period)
0	100	0.5
70	30	25
60	40	10
0	100	250

#### 15.3.2. Performance criterion: B&C



15.3.3. Severity level for EN61000-6-1

Test Level %UT	Voltage dip and short interruptions %UT	Duration (in period)
0	100	0.5
0	100	1
70	30	25
0	100	250

15.3.4. Performance criterion: **B&C**

15.4. Operating Condition of EUT

15.4.1. Turn on the power.

15.4.2. After that, let the EUT work in test mode (Charging, Discharging) and measure it.

15.5. Test Procedure

- 1) Set up the EUT and test generator as shown on Section 15.1.2.
- 2) The interruption is introduced at selected phase angles with specified duration.
- 3) Record any degradation of performance.

15.6. Test Result

**PASS**

Please refer to the following page.

(The tests were carried out at: EMTEK (SHENZHEN) CO., LTD. The Certificate Registration Number is L2291, Accredited by CNAS, 2016.10.24, The certificate is valid until 2022.10.28)

## Voltage Dips and Interruptions Test Results

Standard: <input checked="" type="checkbox"/> IEC 61000-4-11		Result: <input checked="" type="checkbox"/> PASS/ <input type="checkbox"/> FAIL		
Applicant : <u>SOLAX POWER NETWORK TECHNOLOGY(ZHEJIANG) CO., LTD.</u>				
EUT : <u>X1-AC</u>		Test Date : <u>September 30, 2018</u>		
M/N : <u>X1-AC-5.0</u>		Temperature : <u>26.4°C</u>		
Input Voltage : <u>AC 230V/50Hz</u>		Humidity : <u>45%</u>		
Test Engineer : <u>LQI</u>				
Test Mode: <u>Charging, Discharging</u>				
Test Level % U <sub>T</sub>	Voltage Dips & Short Interruptions % U <sub>T</sub>	Duration (in periods)	Criterion <input type="checkbox"/> A <input checked="" type="checkbox"/> B <input checked="" type="checkbox"/> C <input type="checkbox"/> D	Result
0	100	0.5P	B	A
60	40	10P	C	B
70	30	25P	C	B
0	100	250P	C	C
Test Mode : <u>Charging, Discharging</u>				
Test Level % U <sub>T</sub>	Voltage Dips & Short Interruptions % U <sub>T</sub>	Duration (in periods)	Criterion <input type="checkbox"/> A <input checked="" type="checkbox"/> B <input checked="" type="checkbox"/> C <input type="checkbox"/> D	Result
0	100	0.5P	B	A
0	100	1P	B	A
70	30	25P	C	B
0	100	250P	C	C
Note:				

## 16. PHOTOGRAPH

### 16.1. Photo of Conducted Emission Measurement



### 16.2. Photo of Radiation Emission Measurement

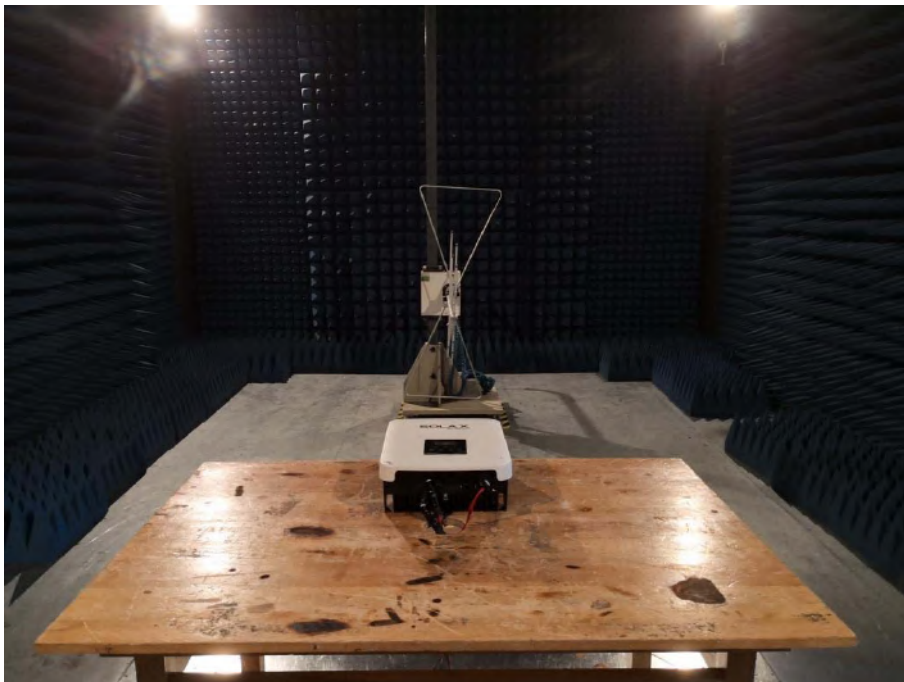

16.3.Photo of Harmonics and Flicker Test



16.4.Photo of Electrostatic Discharge Test



16.5.Photo of RF Field Strength Susceptibility Test

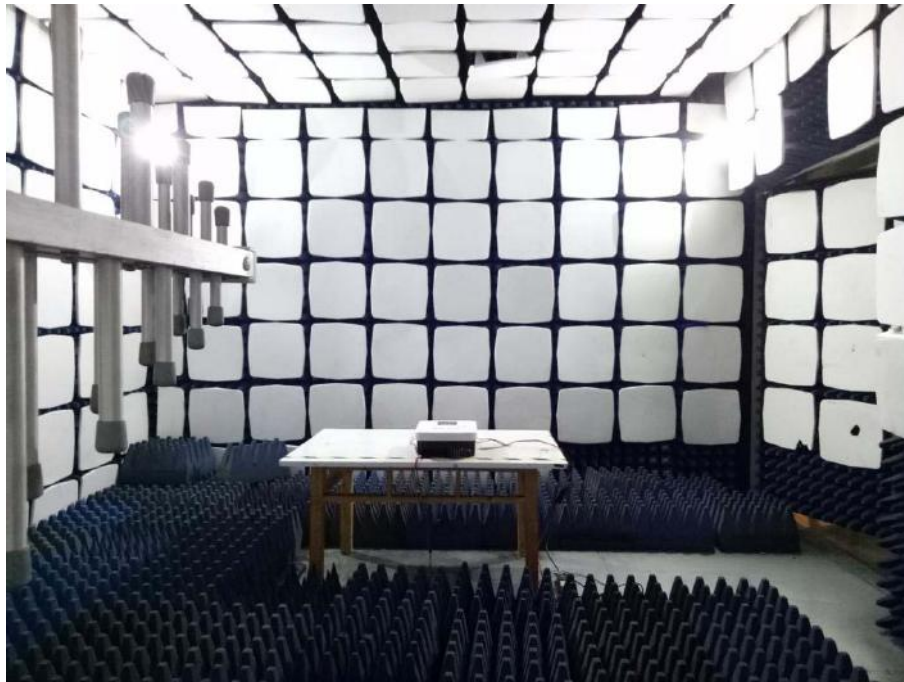

16.6.Photo of Electrical Fast Transient / Burst Test



16.7.Photo of Surge Test



16.8.Photo of Injected Currents Susceptibility Test

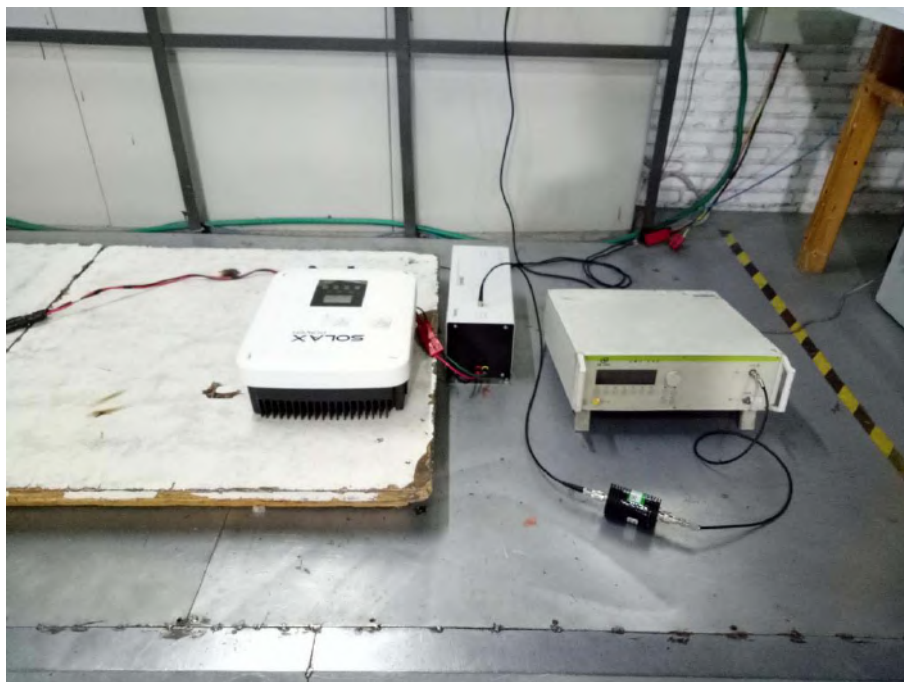

16.9.Photo of Magnetic Field Susceptibility Test

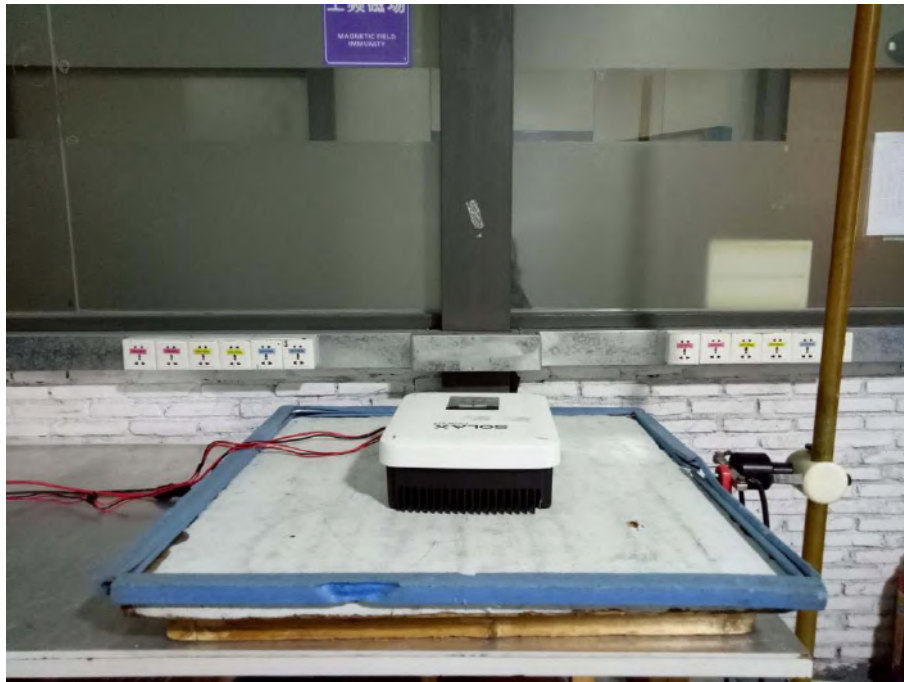

16.10.Photo of Voltage Dips and Interruption Immunity Test



# APPENDIX I (Photo of EUT)



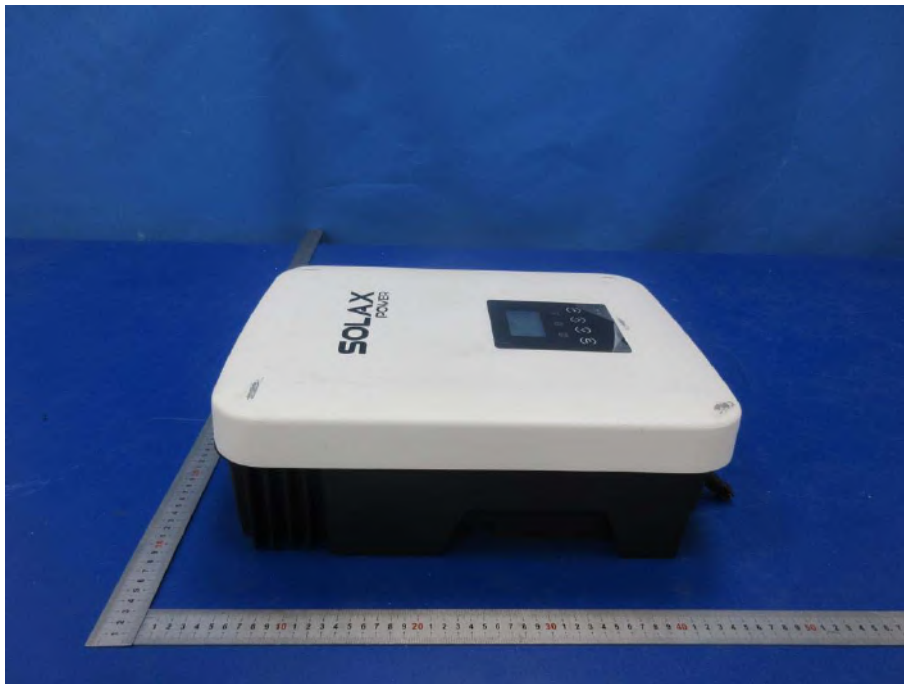
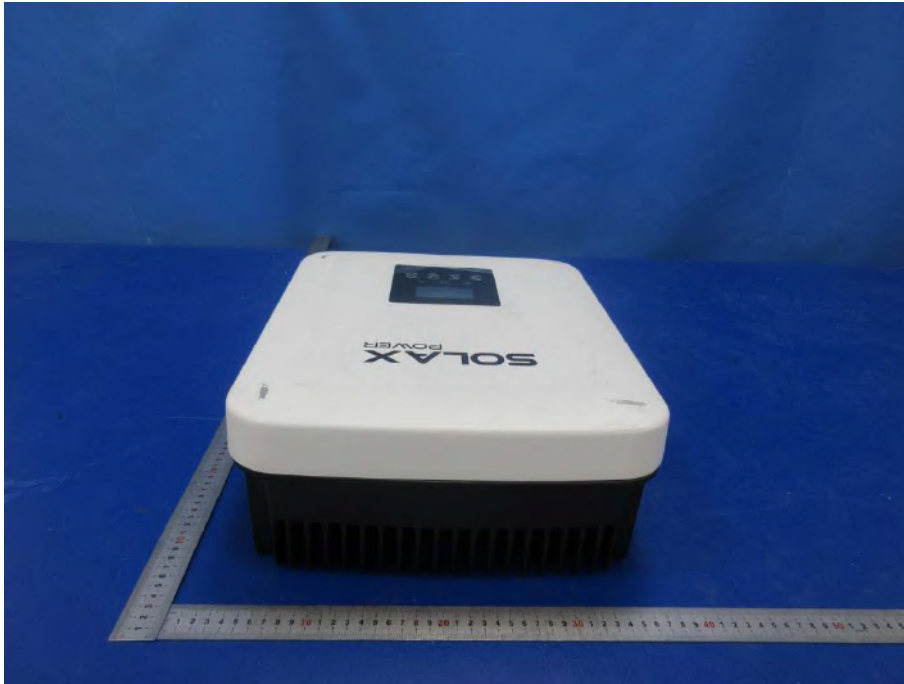

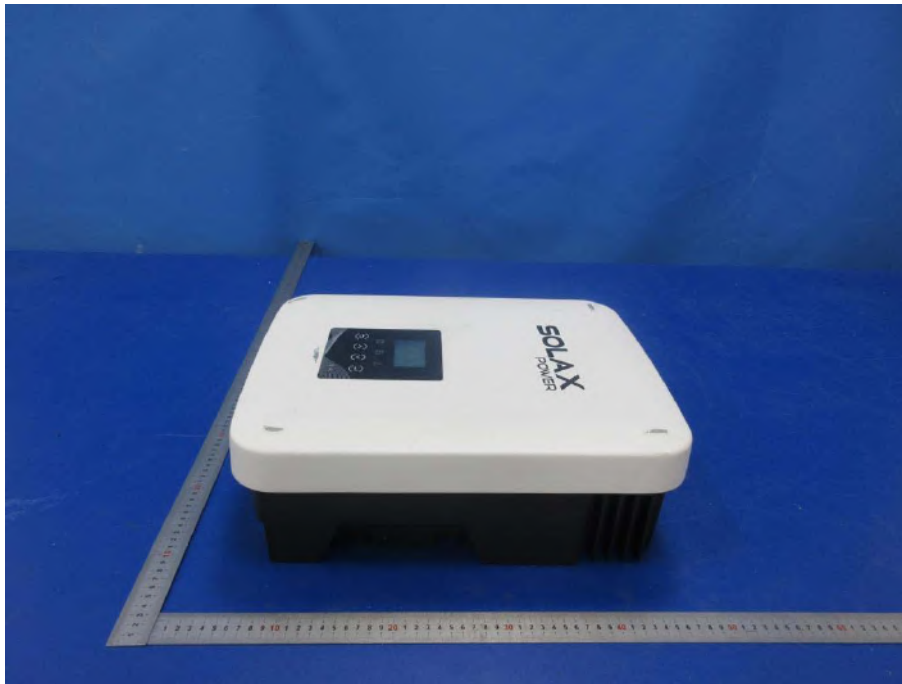

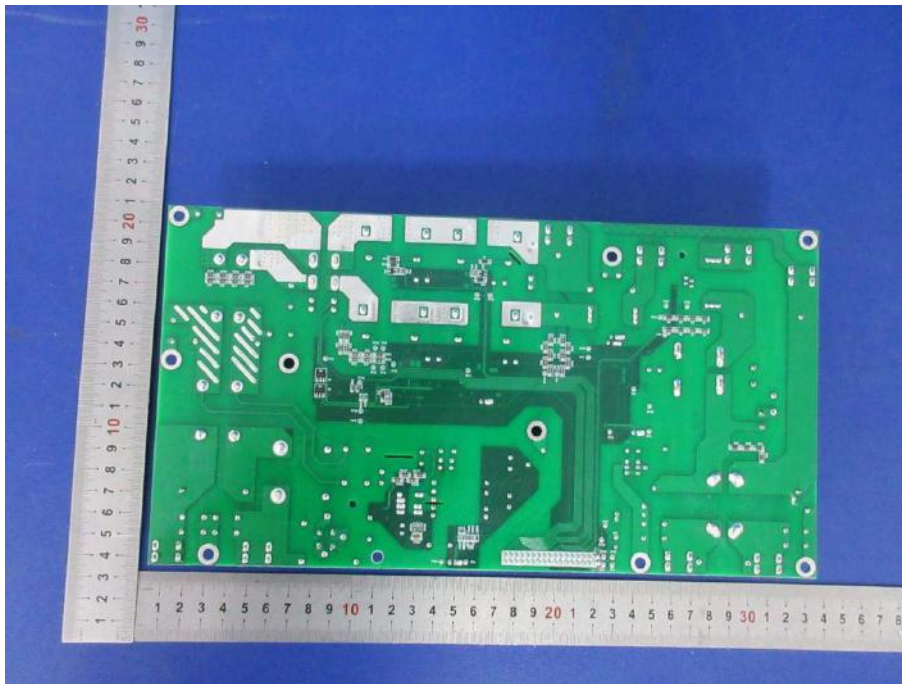
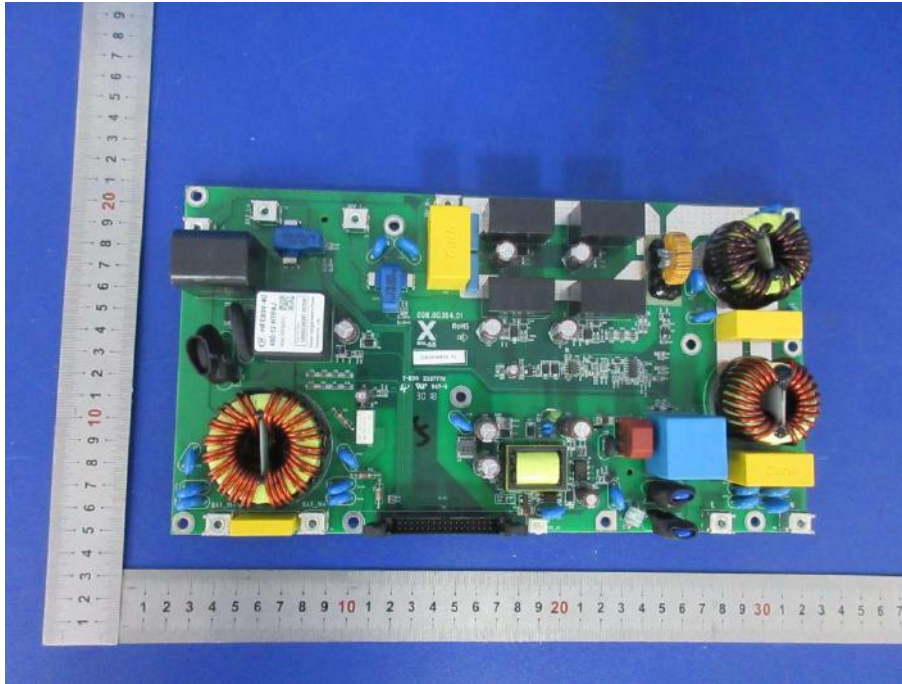



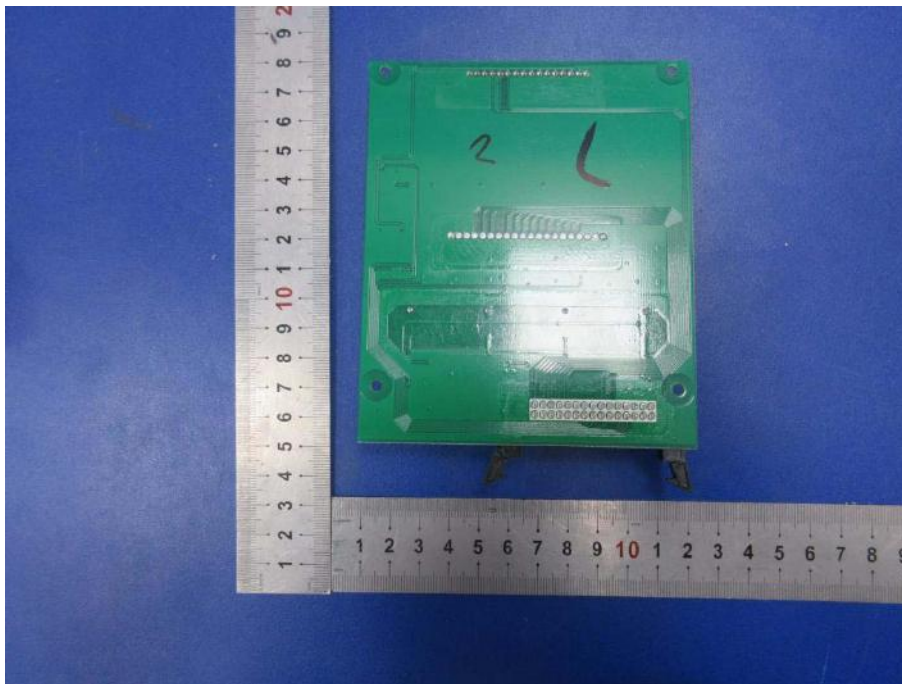
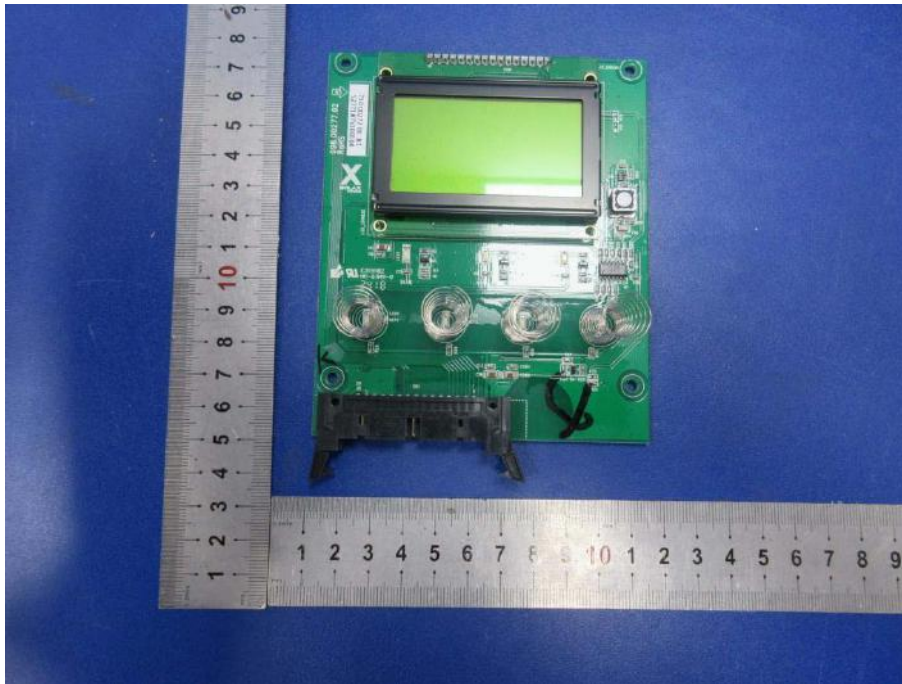

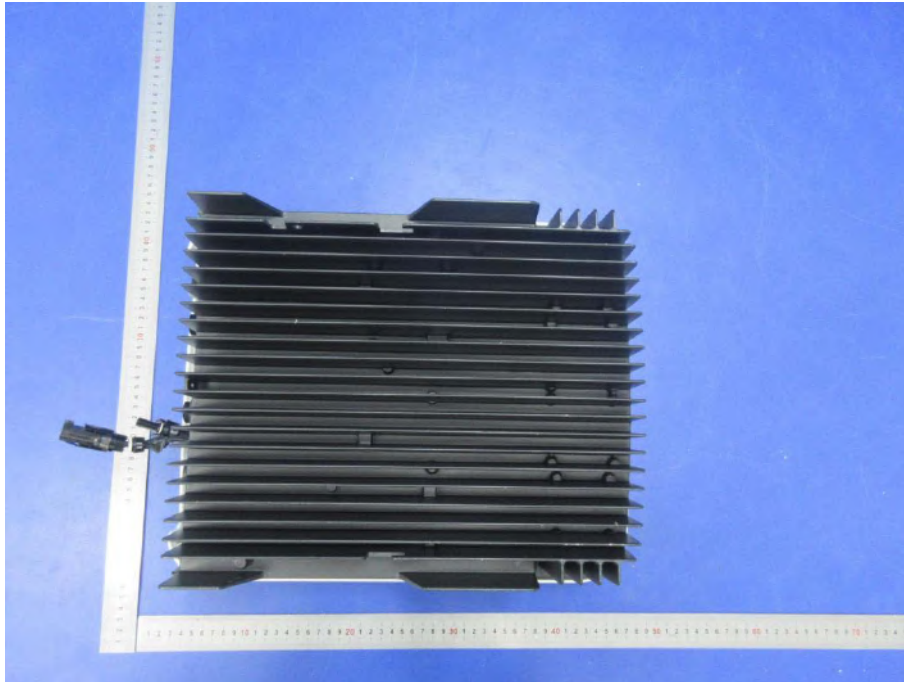

**---The End---**